



晶体管光耦

Photo Transistor

**QX817X**

宁波群芯微电子股份有限公司

NINGBO QUNXIN MICROELECTRONICS CO., LTD.

中国 浙江省宁波杭州湾新区玉海东路 68 号

68 Yuhaidong Road, Hangzhou Bay New District, Ningbo, Zhejiang, China

## 概述 Description

QX817X是一款由发光二极管和光电晶体管组成的光电耦合器。四引脚封装，四种形式（DIP、DIP-M、SMD、SLM）。

The QX817X is a photoelectric coupler composed of light-emitting diode and phototransistor. It is packaged in a 4-pin package at DIP、DIP-M、SMD、SLM.

## 特性 Features

- 电流转换比(CTR)范围: 80%-600% ( $I_F=5\text{mA}$ ,  $V_{CE}=5\text{V}$ ,  $T_a=25^\circ\text{C}$ )  
Current transfer ratio: 80%-600% ( $I_F=5\text{mA}$ ,  $V_{CE}=5\text{V}$ ,  $T_a=25^\circ\text{C}$ )
- 输入-输出隔离电压 ( $V_{ISO}=5000\text{Vrms}$ )  
High isolation voltage between input and output( $V_{ISO}=5000\text{Vrms}$ )
- 集电极-发射极击穿电压  $BV_{CEO}\geq 80\text{V}$   
Collector - emitter breakdown voltage  $BV_{CEO}\geq 80\text{V}$
- 工作温度:  $-55^\circ\text{C}\sim 110^\circ\text{C}$   
Operating Temperature:  $-55^\circ\text{C}\sim 110^\circ\text{C}$
- 符合加强绝缘标准  
Meet reinforced insulation standards
- 符合安规标准: UL 1577, VDE DIN EN60747-5-5 (VDE 0884-5), CQC11-471543-2022  
Meet safety standard approval: UL 1577, VDE DIN EN60747-5-5 (VDE 0884-5), CQC11-471543-2022

## 应用 Applications

- 开关电源, 智能电表  
Switching power supply, intelligent meter
- 工业控制, 测量仪器  
Industrial control, measuring instruments
- 办公设备, 比如复印机  
Office equipment such as copiers
- 家用电器, 比如空调、风扇、热水器等  
Household appliances: such as air conditioners, fans, water heaters, etc.

## 封装和原理图 Package and Schematic Diagram

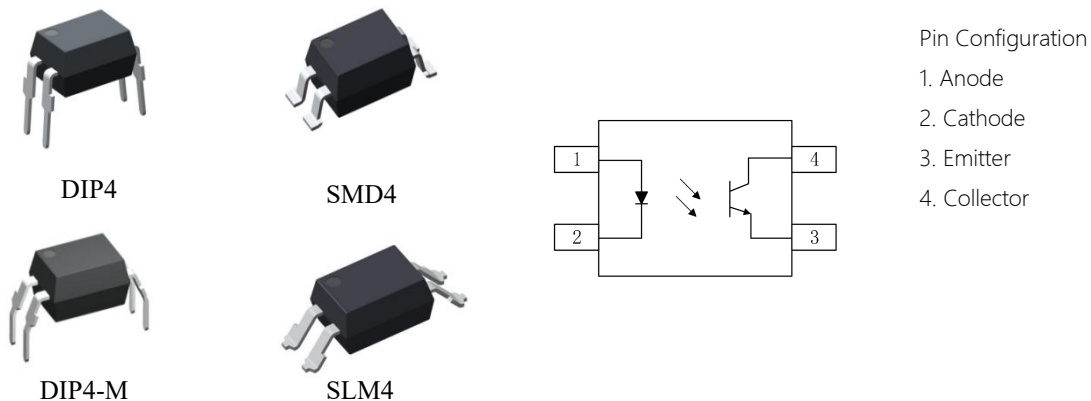



**产品型号命名规则 Order Code**

**QX 817 X - UN Y - W (V) (ZZ)**

① ② ③ ④ ⑤ ⑥ ⑦ ⑧

- ① 公司代码 Company Code (QX: 群芯 Qunxin)
- ② 产品系列 Product Series (817: 817)
- ③ CTR 档位 Classification (代码 Code: A、B、C、D or None)
- ④ 框架类型 Lead Frame (Cu: 铜框架 Copper, Fe: 铁框架 Ferrum)
- ⑤ 树脂类型 Epoxy Type (H: 无卤 Halogen-free)
- ⑥ 封装形式 Package (D:DIP, S:SMD, M:DIP-M, L:SLM)
- ⑦ 特殊范围细分档位 (T: D1, Y: D2) 或无 Special Range Subdivision Code (T: D1, Y: D2) or none
- ⑧ 内部补充代码 Internal Supplementary Code (数字或者空白 Number or None)

**印字信息 Marking Information**

- 印字中“”为群芯品牌 LOGO  
“”denotes LOGO
- 印字中的“X”代表产品分档: A、B、C、D 或空白  
“X”denotes the classification: A、B、C、D or None
- 印字中“Y”代表年份; A(2018),B(2019),C(2020).....  
“Y”denotes YEAR: A(2018), B(2019), C(2020).....
- 印字中“WW”代表周号  
“WW”denotes Week’s number
- 印字中“N”代表星期几  
“N”denotes day of the week
- 印字中的“H”代表无卤  
“H”denotes Halogen-free



**绝缘和安规信息 Insulation and Safety related specifications**

项目 Item	符号 Symbol	数值 Value	单位 Unit	备注 Remark
爬电距离 Creepage Distance	L	> 7.0	mm	从输入端到输出端，沿本体最短距离路径 Measured from input terminals to output terminals, shortest distance path along body
电气间隙 Clearance Distance	L	> 7.0	mm	从输入端到输出端，通过空气的最短距离 Measured from input terminals to output terminals, shortest distance through air
绝缘距离 Insulation Thickness	DTI	> 0.4	mm	发射器和探测器之间的绝缘厚度 Insulation thickness between emitter and detector
峰值隔离电压 Peak Isolation Voltage	$V_{IORM}$	1500	$V_{peak}$	DIN/EN/IEC EN60747-5-5
瞬态隔离电压 Transient isolation voltage	$V_{IOTM}$	7000	$V_{peak}$	DIN/EN/IEC EN60747-5-5
隔离电压 Isolation Voltage	$V_{iso}$	> 5000	$V_{rms}$	For 1 min, RH < 60%

**极限参数 Absolute Maximum Ratings (Ta=25°C)**

参数 Parameter		符号 Symbol	额定值 Rating	单位 Unit
发射端 Input	正向电流 Forward Current	$I_F$	50	mA
	峰值正向电流(1us, 脉冲) Peak forward current (1us, pulse)	$I_{FP}$	1000	mA
	反向电压 Reverse Voltage	$V_R$	6	V
	功耗 Power Dissipation	$P_D$	70	mW
接收端 output	集电极功耗 Collector Power Dissipation	$P_C$	150	mW
	集电极电流 Collector Current	$I_C$	50	mA
	集电极-发射极电压 Collector-Emitter Voltage	$V_{CEO}$	80	V
	发射极-集电极电压 Emitter - Collector Voltage	$V_{ECO}$	6	V
工作温度 Operating Temperature		$T_{opr}$	-55~+110	°C
存储温度 Storage Temperature		$T_{stg}$	-55~+125	°C
焊接温度 Soldering Temperature		$T_{sol}$	260	°C

### 产品特性参数 Electro-optical Characteristics (Ta=25°C)

参数 Parameter		符号 Symbol	条件 Condition	最小 Min.	典型 Typ.	最大 Max.	单位 Unit
发射端 Input	正向电压 Forward Voltage	$V_F$	$I_F=20mA$	-	1.2	1.4	V
	反向电流 Reverse Current	$I_R$	$V_R=4V$	-	-	10	$\mu A$
	输入电容 Terminal Capacitance	$C_t$	$V=0, F=1kHz$	-	30	250	pF
接收端 Output	集电极暗电流 Collector Dark Current	$I_{CEO}$	$V_{CE}=20V$	-	-	100	nA
	集电极-发射极击穿电压 Collector-Emitter Breakdown Voltage	$BV_{CEO}$	$I_C=0.1mA, I_F=0$	80	-	-	V
	发射极-集电极击穿电压 Emitter-Collector Breakdown Voltage	$BV_{ECO}$	$I_E=10\mu A, I_F=0$	6	-	-	V
传输特性 Transfer Characteristics	电流传输比 Current Transfer Ratio	$CTR^*$	$I_F=5mA, V_{CE}=5V$	80	-	600	%
	集电极-发射极饱和压降 Collector-Emitter Saturation Voltage	$V_{CE(sat)}$	$I_F=20mA, I_C=1mA$	-	0.1	0.2	V
	隔离电阻 Isolation Resistance	$R_{ISO}$	$V_{I-O}=DC500V$ 40~60%R.H.	$1 \times 10^{12}$	-	-	$\Omega$
	隔离电容 Isolation capacitance	$C_{ISO}$	$V=0, F=1MHz$	-	0.6	1.0	pF
	截至频率 Cut-off Frequency	$F_c$	$V_{CE}=5V, I_C=2mA,$ $R_L=100\Omega, -3dB$	-	80	-	KHz
	上升时间 Rise Time	$T_r$	$V_{CE}=2V, I_C=2mA$ $R_L=100\Omega$	-	4	18	$\mu s$
	下降时间 Fall Time	$T_f$	$V_{CE}=2V, I_C=2mA,$ $R_L=100\Omega$	-	3	18	$\mu s$

注\*: 电流传输比= $I_C/I_F \times 100\%$ 。

Note\*:  $CTR=I_C/I_F \times 100\%$ 。

### 电流传输比分档表 CTR Classification Table ( $I_F=5mA, V_{CE}=5V, Ta=25^\circ C$ )

代码 Code	最小值 Min.	最大值 Max.
None	80	600
A	80	160
B	130	260
C	200	400
D	300	600
D1	300	450
D2	380	600

**典型光电特性曲线 Typical Electro-Optical Characteristics Curves**

Fig.1 Allowable Forward Current VS Ambient Temperature

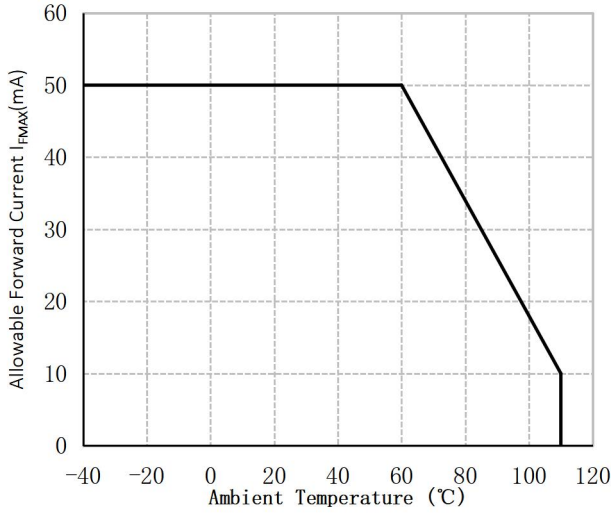

Fig.2 Allowable collector power dissipation VS Ambient Temperature (°C)

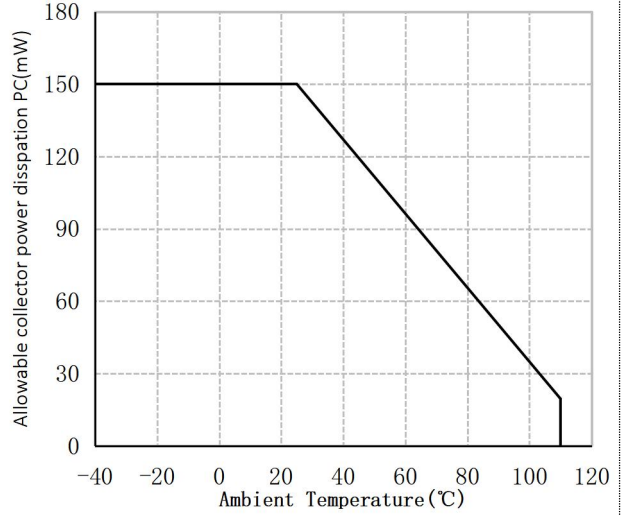

Fig.3 Relative Current Transfer Ratio vs. Forward Current

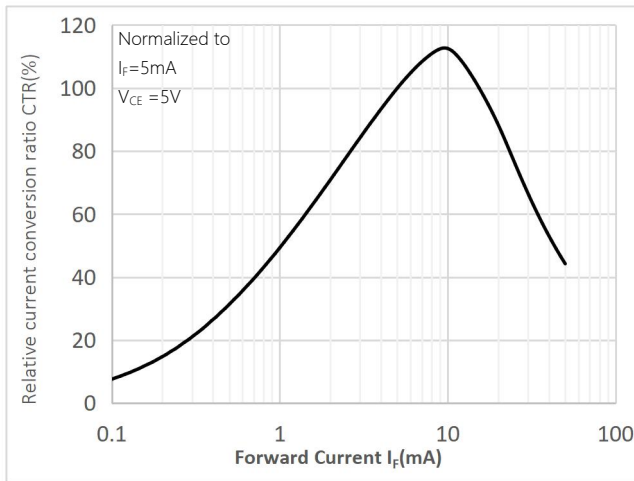

Fig.4 Forward Current vs. Forward Voltage

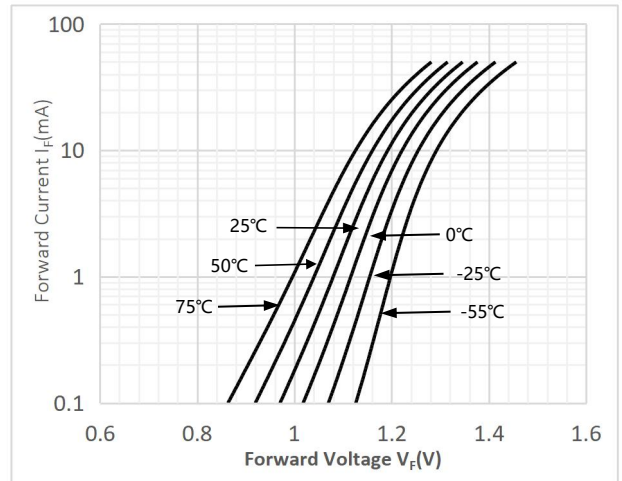

Fig.5 Collector Current vs. Collector-emitter Voltage

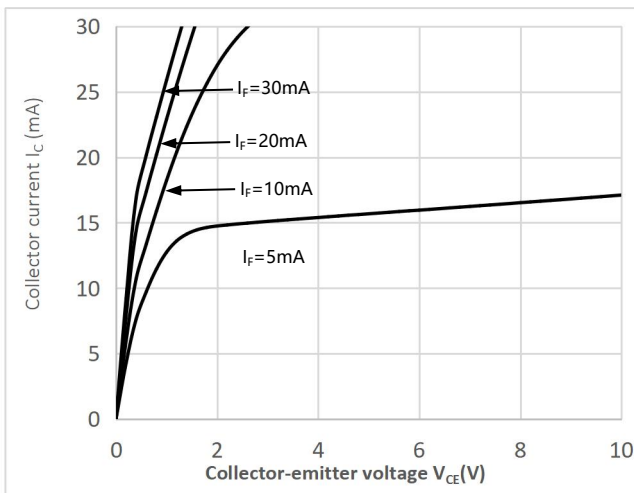

Fig.6 Relative Current Transfer Ratio vs. Ambient Temperature

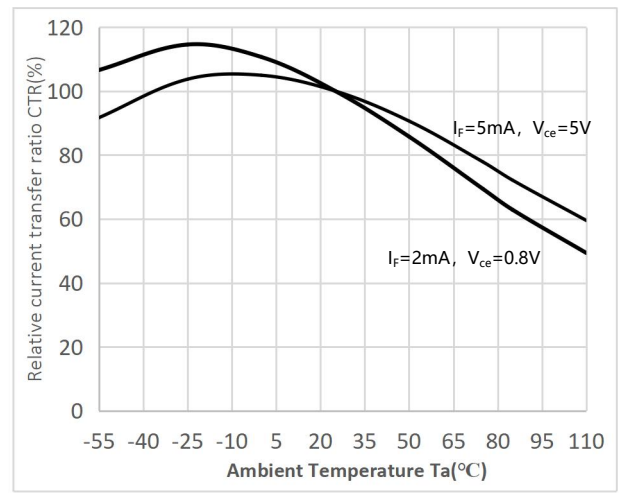

Fig.7 Collector-emitter Saturation Voltage vs. Ambient Temperature

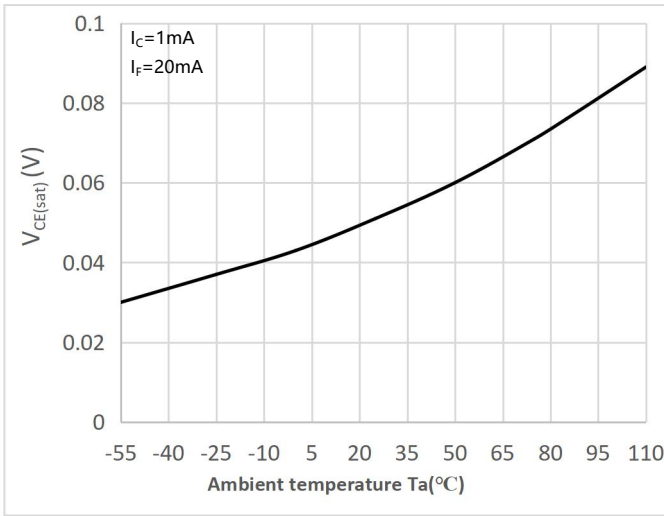

Fig.8 Collector Dark Current vs. Ambient Temperature

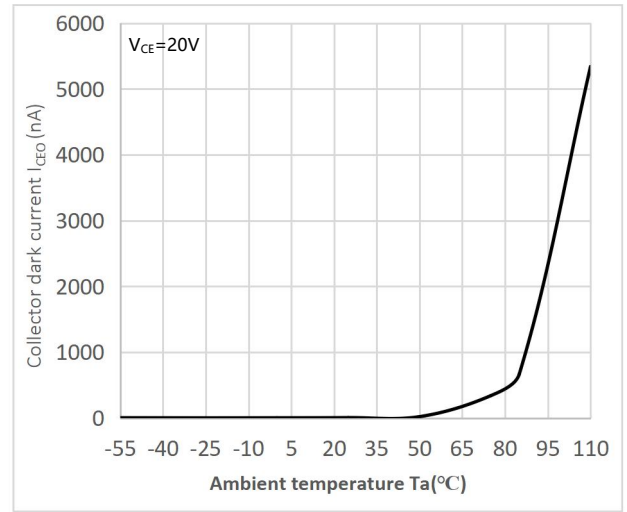

Fig.9 Response Time vs. Load Resistance

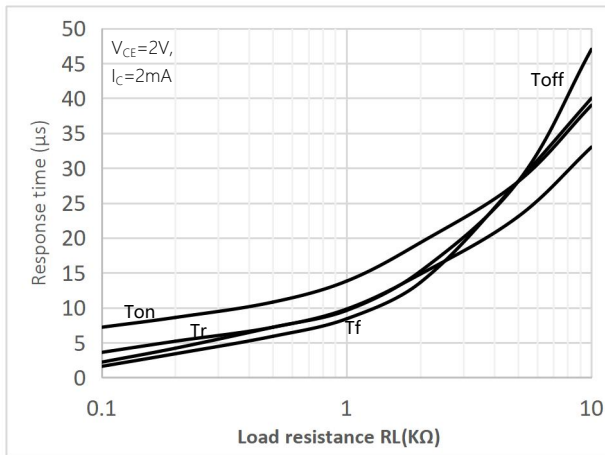

Fig.10 Frequency Response

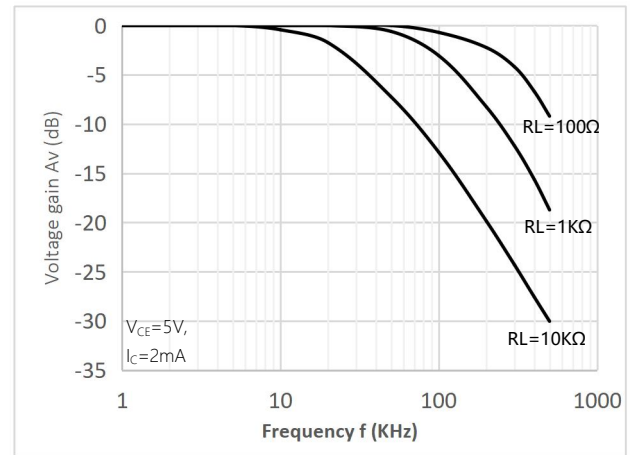

Fig.11 Collector-emitter Saturation Voltage vs Forward Current

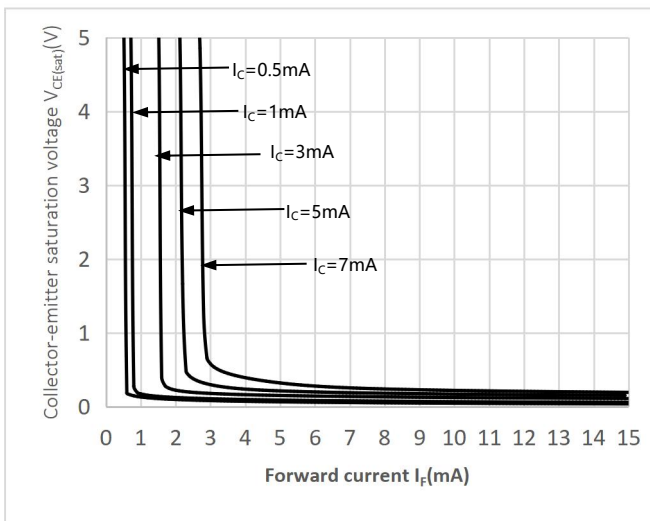
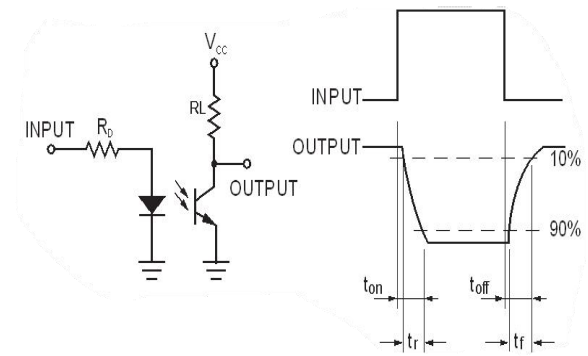
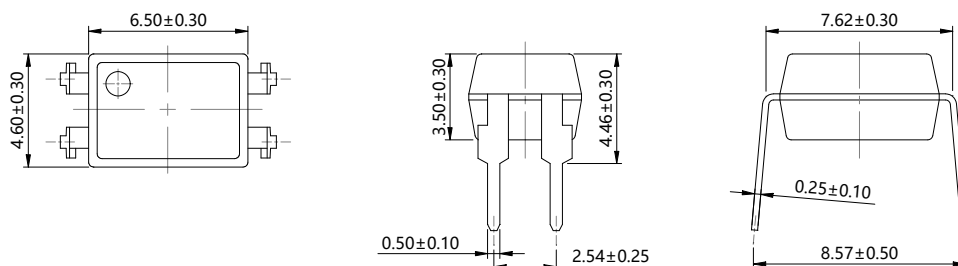

Fig.12 Switching Time Test Circuit & Waveforms



**外形尺寸 Outline Dimensions**

DIP4



DIP4-M

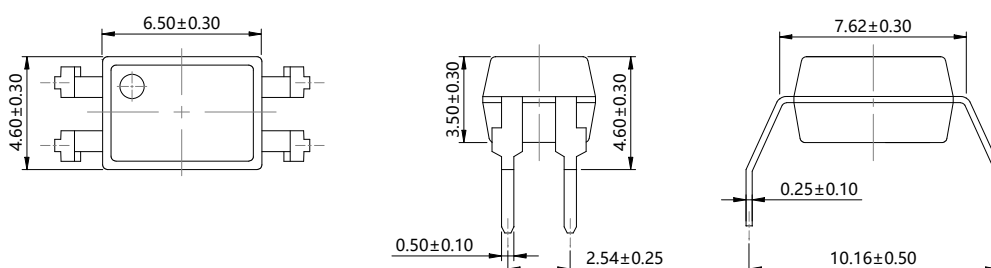

SMD4

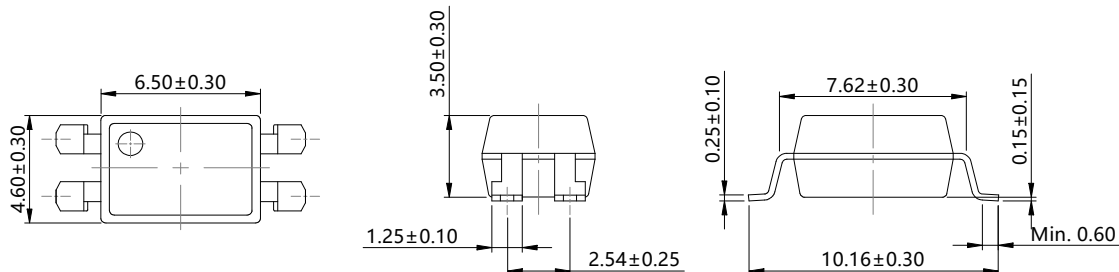

SLM4

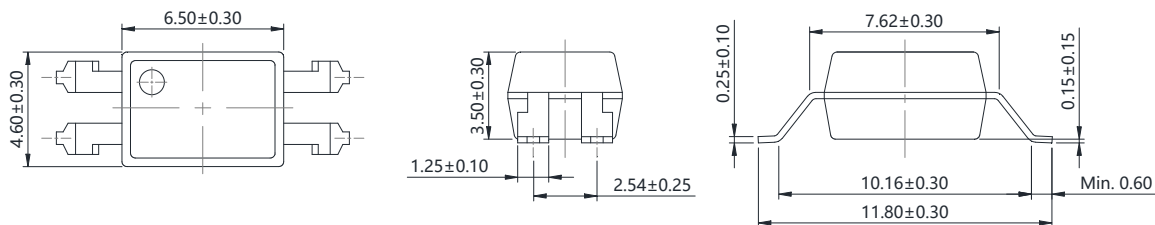

单位 Unit: mm



**建议焊盘布局 Recommended Pad Layout**

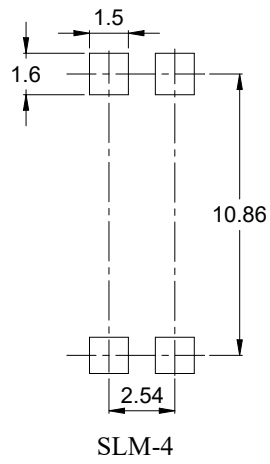
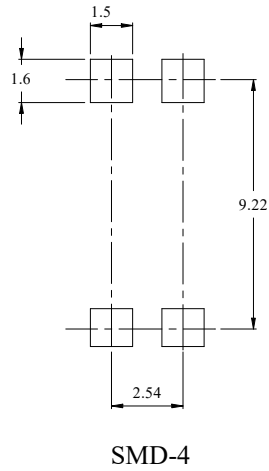

单位 Unit: mm

注：上图为产品正视图。

Note: The picture above is the front view of the product.

**回流焊温度曲线图 Solder Reflow Profile**

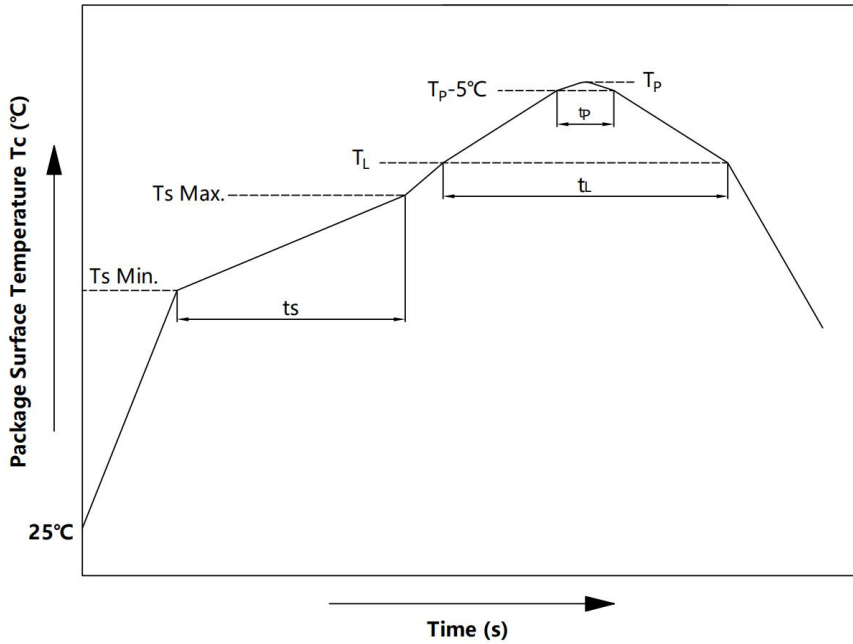

项目 Item	符号 Symbol	最小值 Min.	最大值 Max.	单位 Unit
预热温度 Preheat Temperature	$T_s$	150	200	$^\circ\text{C}$
预热时间 Preheat Time	$t_s$	60	120	s
升温速率 Ramp-Up Rate ( $T_L$ to $T_P$ )	-	-	3	$^\circ\text{C}/\text{s}$
液相线温度 Liquidus Temperature	$T_L$	217		$^\circ\text{C}$
时间高于 $T_L$ Time Above $T_L$	$t_L$	60	150	s
峰值温度 Peak Temperature	$T_P$	-	260	$^\circ\text{C}$
$T_c$ 在 $(T_P-5)$ 和 $T_P$ 之间的时间 Time During Which $T_c$ Is Between $(T_P-5)$ and $T_P$	$t_p$	-	30	s
降温速率 Ramp-down Rate ( $T_P$ to $T_L$ )	-	-	6	$^\circ\text{C}/\text{s}$

注 Note:

建议在所示的温度和时间条件下进行回流焊，最多不能超过三次；

Reflow soldering is recommended at the temperatures and times shown, no more than three times;

### 波峰焊温度曲线图 Wave Soldering Profile

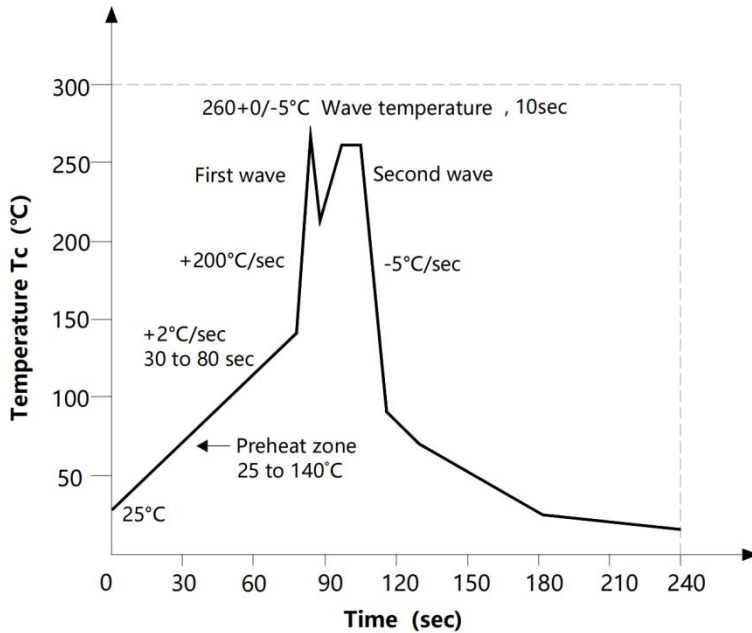

### 手工烙铁焊接 Soldering with hand soldering iron

- A. 手工烙铁焊仅用于产品返修或样品测试;  
Hand soldering iron is only used for product rework or sample testing;
- B. 手工烙铁焊要求: 温度  $360^{\circ}\text{C} \pm 5^{\circ}\text{C}$ , 时间  $\leq 3\text{s}$ 。  
Hand soldering iron requirements: Temperature:  $360^{\circ}\text{C} \pm 5^{\circ}\text{C}$ , within 3s.

**包装 Packing**

■ 汇总表 Summary table

封装形式	包装方式	盘数量	盒数量	箱数量	静电袋规格	盒规格	箱(双瓦楞)规格	备注
SMD4	卷盘 (φ330mm 蓝盘)	2000 只/盘	2 盘/盒	10 盒/箱	450*390*0.1mm	353*340*60mm	650*375*365mm	首端空 50 个空格, 末端空 100 个空格
SLM4	卷盘 (φ330mm 蓝盘)	2000 只/盘	2 盘/盒	8 盒/箱	450*390*0.1mm	340*340*75mm	650*375*365mm	
DIP4	管装 (500*12*11mm)	100 只/管	50 管/盒	10 盒/箱	不适用	525*130*57mm	550*280*320mm	每管使用蓝白胶塞, 方向须一致
DIP4-M	管装 (500*13*11mm)	100 只/管	45 管/盒	10 盒/箱	不适用	525*130*57mm	550*280*320mm	
Package Type	Packing Form	Quantity per Reel	Quantity per Box	Quantity per Carton	Antistatic Bag Specification	Box Specification	Carton Specification	Note
SMD4	Reel (φ330mm Blue)	2000 pcs/reel	2 reels/box	10 boxes/ctn	450*390*0.1mm	353*340*60mm	650*375*365mm	Leave 50 Spaces at the beginning and 100 Spaces at the end
SLM4	Reel (φ330mm Blue)	2000 pcs/reel	2 reels/box	8 boxes/ctn	450*390*0.1mm	340*340*75mm	650*375*365mm	
DIP4	Tube (500*12*11mm)	100 pcs /tube	50 tubes/box	10 boxes/ctn	NA	525*130*57mm	550*280*320mm	End plug (blue) and End plug (white) keep the direction
DIP4-M	Tube (500*13*11mm)	100 pcs /tube	45 tubes/box	10 boxes/ctn	NA	525*130*57mm	550*280*320mm	

■ 编带包装 Tape & Reel

- 1) 每卷数量: 2000 只。  
Qty/reel: 2000 pcs.
- 2) 每箱数量: 40000 只。  
Qty/ctn: 40000 pcs.
- 3) 内包装: 每盒 2 盘。  
Inner packing: 2 reels/box.
- 4) 示意图 Schematic:

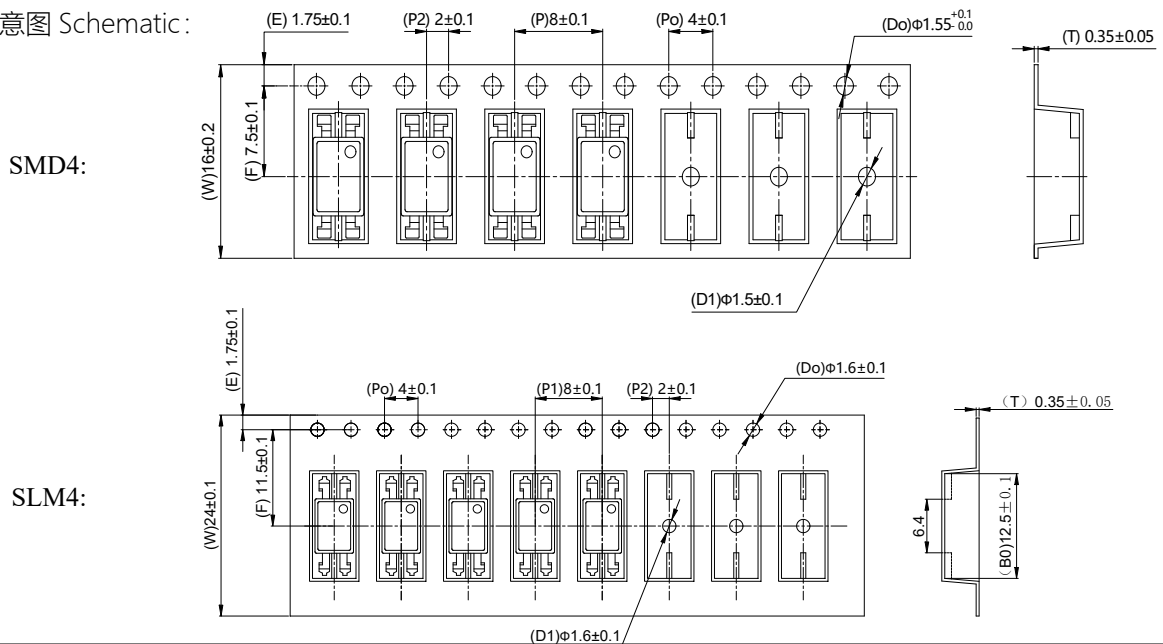

■ 管条包装 Tape & Tube

- 1) 每管数量：100 只。  
Qty/Tube: 100 pcs.
- 2) 每箱数量 DIP4/DIP4-M: 50000/45000 只。  
Qty/ctn DIP4/DIP4-M: 50000/45000 pcs.
- 3) 内包装 DIP4/DIP4-M: 每盒 50/45 管。  
Inner packing DIP4/DIP4-M: 50/45 Tube/box.
- 4) 示意图 Schematic:

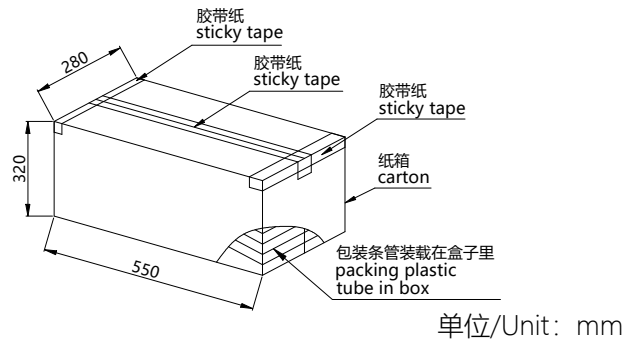

## 注意 Attention

- 群芯持续不断改进质量、可靠性、功能或设计，保留此文件更改的权利恕不另行通知。  
QUNXIN continuously improve quality, reliability, function and design. We reserve the right to change this document without prior notice.
- 请遵守产品规格书使用，群芯不对使用时不符合产品规格书条件而导致的质量问题负责。  
Please use in accordance with the product specification. QUNXIN is not responsible for the quality problems caused by non-compliance with the product specifications.
- 对于需要高可靠性或安全性的设备/装置需求，请联系我们的销售人员。  
For equipment/devices requiring high reliability or safety, please contact our sales representatives.
- 当需要用于任何“特定”应用时，请咨询我们的销售人员。  
When requiring a device for any “specific” application, please contact our sales in advice.
- 如对文件中表述的内容有疑问，欢迎联系我们。  
If you have any questions about the contents of the document, please contact us.