



智能功率模块接口光耦

Intelligent Power Module

QX481

宁波群芯微电子股份有限公司

NINGBO QUNXIN MICROELECTRONICS CO., LTD.

中国 浙江省宁波杭州湾新区玉海东路 68 号

68 Yuhaidong Road, Hangzhou Bay New District, Ningbo, Zhejiang, China

概述 Description

QX481 高速光耦合器包含一个 GaAsP LED 和一个光电探测器，内置施密特触发器，提供逻辑兼容波形，可节省额外波形整形需求。

The high-speed QX-480 optocoupler contains a GaAsP LED and a photodetector, built-in Schmitt trigger, and provides logic compatible waveforms, which can save additional waveform shaping requirements.

特性 Features

- 较宽的工作温度：-40°C to 100°C
Operating temperature: -40°C to 100°C
- 较宽的工作电压：4.5V to 20V
Operating voltage: 4.5V to 20V
- 传播延迟时间 $t_{PHL}/t_{PLH} \leq 350$ ns
Propagation Delay Time $t_{PHL}/t_{PLH} \leq 350$ ns
- 最大脉冲宽度失真(PWD)=250ns
Pulse Width Distortion(PWD)=250ns(max)
- 传输延迟的差异-100ns < PDD < 250ns
Propagation Delay Difference:
-100ns < PDD < 250ns
- VCM=1000V 时，最低 20kV/μs 共模抑制能力
CMR(min):20kV/μs (VCM=1000V)
- 符合安规标准：UL 1577, VDE DIN EN60747-5-5 (VDE 0884-5), CQC11-471543-2022
Meet safety standard : UL 1577, VDE DIN EN60747-5-5 (VDE 0884-5) , CQC11-471543-2022

应用 Applications

- IPM 接口隔离
IPM Interface Isolation
- 隔离 IGBT/MOSFET 门驱动器
Isolated IGBT/MOSFET Gate Drive
- 交流和无刷直流电机驱动
AC and Brushless DC Motor Drives
- 工业变频器
Industrial Inverters
- 通用数字隔离
General Digital Isolation

真值表 Truth table

LED	VO
OFF	H
ON	L

封装和原理图 Package and Schematic Diagram

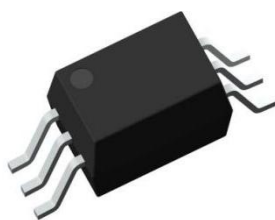

SOP6-W

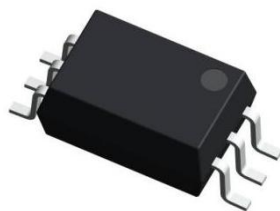

SOP6-P

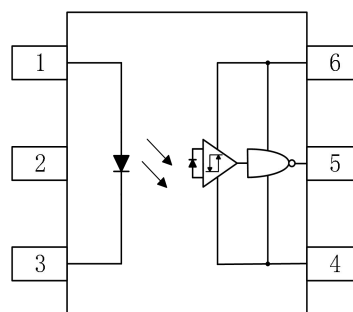

Pin Configuration

1. Anode
2. NC
3. Cathode
4. GND
5. VO
6. VCC

注：4，6 脚之间必须连接 0.1uF 的旁路电容。

Note: A 0.1 μF bypass capacitor must be connected between pins 4 and 6.



产品型号命名规则 Order Code

QX 481 - UN Y - W (V) (ZZ)

① ② ③ ④ ⑤ ⑥ ⑦

- ① 公司代码 Company Code (QX: 群芯 Qunxin)
- ② 产品系列 Product Series (481)
- ③ 框架类型 Lead Frame (Cu: 铜框架 Copper)
- ④ 树脂类型 Epoxy Type (H: 无卤 Halogen-free)
- ⑤ 封装形式 Package (W: SOP6-W ; P: SOP6-P)
- ⑥ 器件工作温度范围 Device Operating Temperature Range (特殊范围需填或者空白 Special Range need to be filled in or left blank)
- ⑦ 内部补充代码 Internal Supplementary Code (数字或者空白 Number or None)

印字信息 Marking Information

- 印字中“”为群芯品牌 LOGO
“”denotes LOGO
- 印字中“Y”代表年份; A(2018),B(2019),C(2020).....
“Y”denotes YEAR: A(2018), B(2019), C(2020).....
- 印字中“WW”代表周号
“WW”denotes week’s number
- 印字中“N”代表星期几
“N”denotes day of the week
- 印字中的“H”代表无卤
“H”denotes Halogen-free



绝缘和安规信息 Insulation and Safety related specifications

项目 Item	符号 Symbol	数值 Value	单位 Unit	备注 Remark
爬电距离 Creepage Distance	L	> 8.0	mm	从输入端到输出端，沿本体最短距离路径 Measured from input terminals to output terminals, shortest distance path along body
电气间隙 Clearance Distance	L	> 8.0	mm	从输入端到输出端，通过空气的最短距离 Measured from input terminals to output terminals, shortest distance through air
绝缘距离 Insulation Thickness	DTI	> 0.4	mm	发射器和探测器之间的绝缘厚度 Insulation thickness between emitter and detector
峰值隔离电压 Peak Isolation Voltage	V_{IORM}	1500	V_{peak}	DIN/EN/DIN EN60747-5-5
瞬态隔离电压 Transient isolation voltage	V_{IOTM}	7000	V_{peak}	DIN/EN/DIN EN60747-5-5
隔离电压 Isolation Voltage	V_{iso}	> 5000	V_{rms}	For 1 min

极限参数 Absolute Maximum Ratings ($T_a=25^{\circ}C$)

参数 Parameter		符号 Symbol	额定值 Rating	单位 Unit	
发射端 Input	平均输入电流 Average Input Current	$I_{F(AVG)}$	10	mA	
	峰值瞬态输入电流 Peak Transient Input Current	$I_{F(TRAN)}$	脉宽<1 us, 300pps pulse width<1 us, 300pps	1.0	A
			脉宽<200 us 占空比<1% pulse width<200 us Duty Cycle<1%	40	mA
	反向电压 Reverse Input Voltage	V_R	5	V	
	输入功耗 Input Power Dissipation	P_I	45	mW	
接收端 output	平均输出电流 Average Output Current	I_O	25	mA	
	电源电压 Supply Voltage	V_{CC}	25	V	
	输出电压 Output Voltage	V_O	-0.5~ V_{CC}	V	
总功耗 Total Power Dissipation	P_{tot}	210	mW		
隔离电压 Isolation voltage	V_{ISO}	5000	V_{rms}		
工作温度 Operating Temperature	T_{opr}	-40~+100	$^{\circ}C$		
存储温度 Storage Temperature	T_{stg}	-55~+125	$^{\circ}C$		

推荐操作条件 Recommended Operating Conditions

参数 Parameter	符号 Symbol	最小值 Min	最大值 Max.	单位 Unit
电源电压 Power Supply Voltage	V_{CC}	4.5	20	V
开启电流 Forward Input Current (ON)	$I_{F(ON)}$	6.0	10.0	mA
关断电压 Forward Input Voltage (OFF)	$V_{F(OFF)}$	0	0.8	V
操作温度 Operating Temperature	T_A	-40	+100	°C

产品特性参数 Electro-optical Characteristics (Ta=25°C)

参数 Parameter	符号 Symbol	条件 Condition	最小 Min.	典型 Typ.	最大 Max.	单位 Unit	
发射端 Input	正向电压 Forward Voltage	V_F	$I_F=6mA$	1.35	1.7	V	
	反向击穿电压 Reverse Voltage	BV_R	$I_R=10uA$	5		V	
	开启电流 Open the current	I_{FLH}		-	3.0	5	mA
	输入正向电压的温度系数 Temperature Coefcient of Input Forward Voltage	$\Delta V_F/\Delta T_A$	$I_F=6mA$	-	-1.7	-	mV/°C
	输入电容 Capacitance	C_{IN}	$V=0, f=1MHz$	-	60	-	pF
接收端 Output	输出漏电流 Output leakage current	I_{OHH}	$V_{CC}=V_O=5V, V_F=0V$	-	-	200	uA
		$V_{CC}=V_O=20V, V_F=0V$	-	-	500		
	低电平输出短路电流 Low level output Short-circuit power	I_{OSL}	$V_O=V_{CC}=5.5V, I_F=10mA$	25	-	-	mA
		$V_O=V_{CC}=20V, I_F=10mA$	50	-	-		
	高电平输出短路电流 High level output Short-circuit power	I_{OSH}	$V_{CC}=5.5V$ $V_F=0V, V_O=GND$	-	-	-25	mA
		$V_{CC}=20V,$ $V_F=0V, V_O=GND$	-	-	-50	mA	
	高电平电源电流 High Level Supply Current	I_{CCH}	$V_{CC}=5.5V$ $V_F=0V, I_O=0mA$	-	1.0	2.5	mA
			$V_{CC}=20V$ $V_F=0V, I_O=0mA$	-	1.2	2.5	
	低电平电源电流 Low Level Supply Current	I_{CCL}	$V_{CC}=5.5V$ $I_F=10mA, I_O=0mA$	-	1.0	3	mA
			$V_{CC}=20V$ $I_F=10mA, I_O=0mA$	-	1.2	3	
低电平输出电压 Low Level Output Voltage	V_{OL}	$I_{OL}=6.5mA$	-	-	0.5	V	
高电平输出电压 High Level Output Voltage	V_{OH}	$I_{OH}=-6.5mA$	VCC-2.5	VCC-1.1	-	V	

开关特性 Switching Specification

参数 Parameter	符号 Symbol	条件 Condition	最小 Min.	典型 Typ.	最大 Max.	单位 Unit
逻辑低电平传输延迟 Propagation Delay Time to Low Output Level	t_{PHL}	$T_R/T_F=5ns$ 10%duty cycle $Z_O=50\Omega, V_O=5V$ 带峰值电容	-	100	350	ns
逻辑高电平传输延迟 Propagation Delay Time to High Output Level	t_{PLH}		-	100	350	ns
脉宽失真 Pulse Width Distortion $ t_{PHL}-t_{PLH} $	PWD		-	-	250	ns
传输延迟差 Propagation Delay Diference Between Any Two Parts $(t_{PHL}-t_{PLH})^*$	PDD		-100	-	250	ns
输出上升时间 Output Rise Time (10%~90%)	t_R		-	10	-	ns
输出下降时间 Output Fall Time (90%~10%)	t_F		-	10	-	ns
输出高电平共模抑制 Output High Level Common Mode Transient Immunity	$ CM_H $		$T_A=25^\circ C$ $ V_{CM} =1000V$ $I_F=6.0mA, V_{CC}=5V$	20	-	-
输出低电平共模抑制 Output Low Level Common Mode Transient Immunity	$ CM_L $	$T_A=25^\circ C,$ $ V_{CM} =1000V$ $V_F=0V, V_{CC}=5V$	20	-	-	kV/ μs
隔离电阻 Input-Output Resistance	R_{ISO}	$V_{I-O} \leq 500V$	-	10^{12}	-	Ω
隔离电容 Input-Output Capacitance	C_{ISO}	$V_{I-O} = 0V$ Freq=1.0MHz	-	0.6	-	pF

典型光电特性曲线 Typical Electro-Optical Characteristics Curves

Fig.1 Low level voltage vs. Ambient temperature

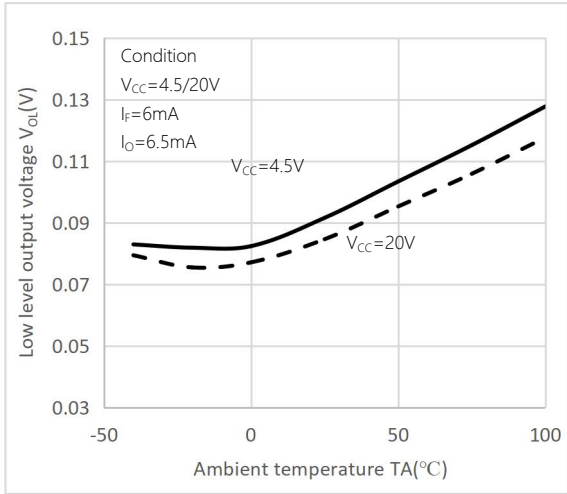

Fig.2 High level output current vs. Ambient temperature

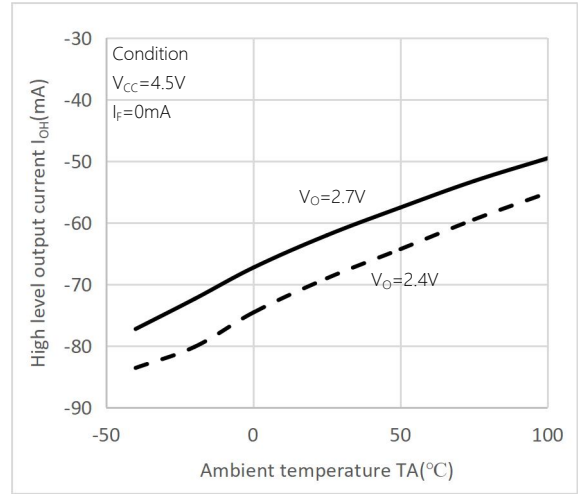

Fig.3 Output voltage vs. Input current

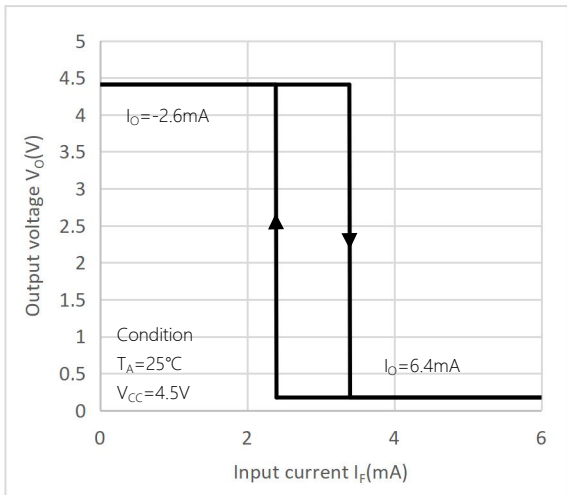

Fig.4 Input current vs. Forward Voltage

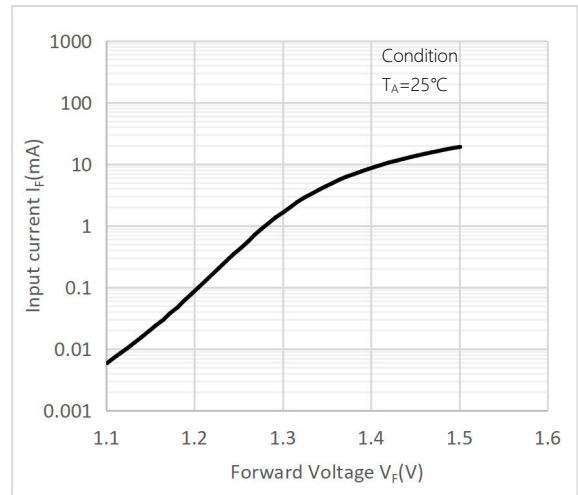

Fig.5 Propagation delay vs. Ambient temperature

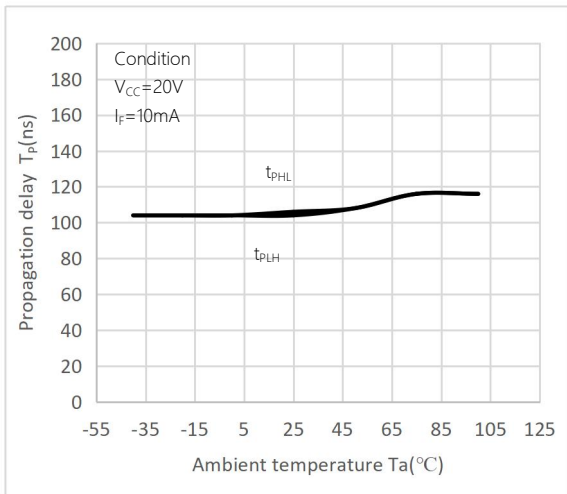

Fig.6 Output voltage vs. Supply Voltage

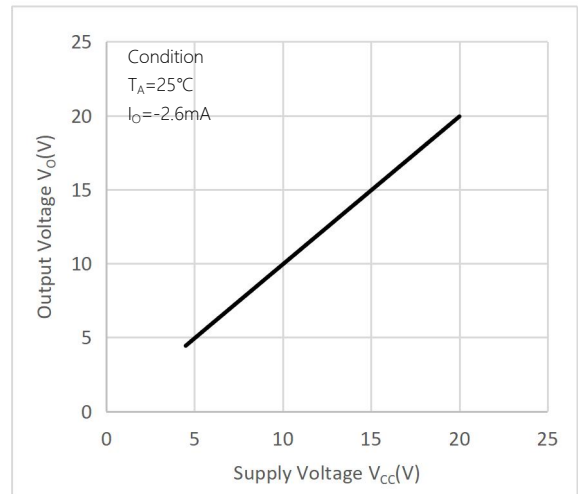
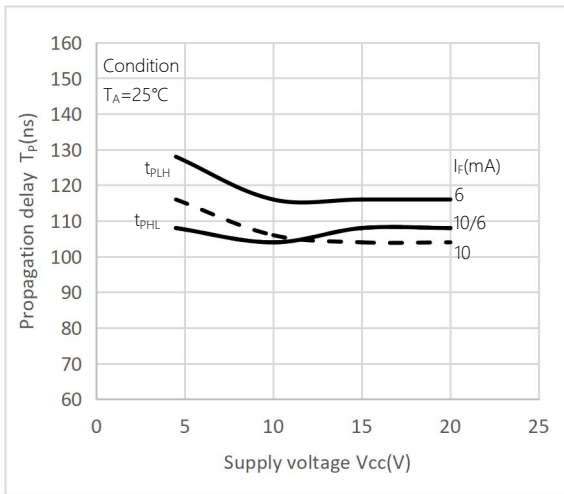
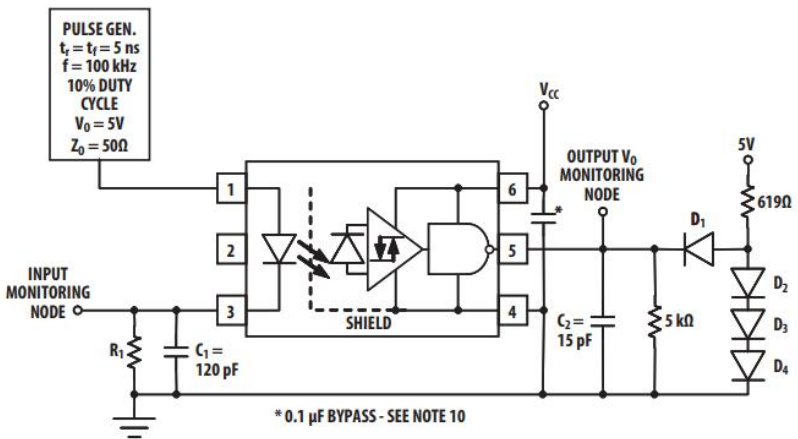

Fig.7 Propagation delay vs. Supply voltage



延迟时间测试电路 Propagation Delay Time Test Circuit



THE PROBE AND JIG CAPACITANCES ARE INCLUDED IN C_1 AND C_2 .

R_1	660 Ω	330 Ω
$I_{F(ON)}$	6 mA	10 mA

ALL DIODES ARE EITHER 1N916 OR 1N3064

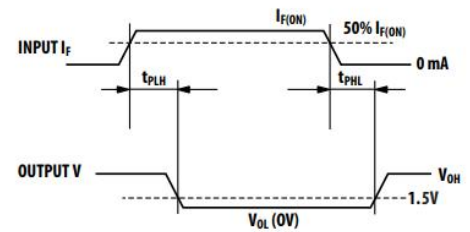

CMR 测试电路 Test Circuit for Common Mode Transient Immunity

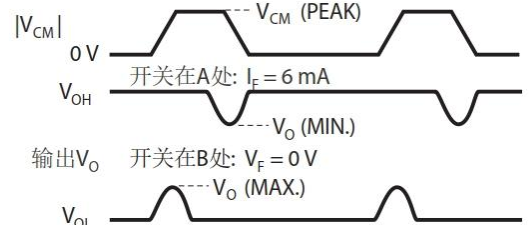
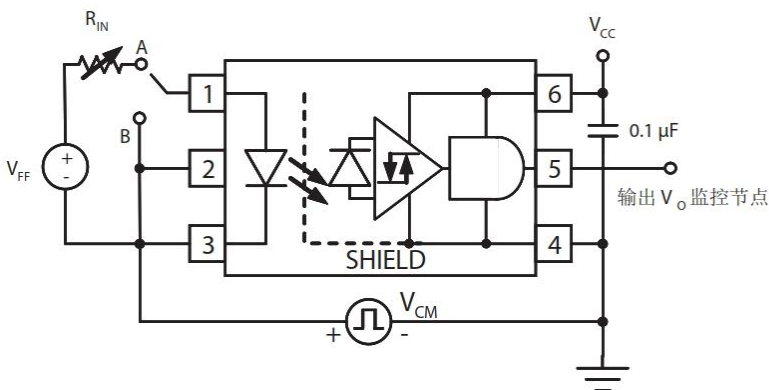

外形尺寸 Outline Dimensions

SOP6-P

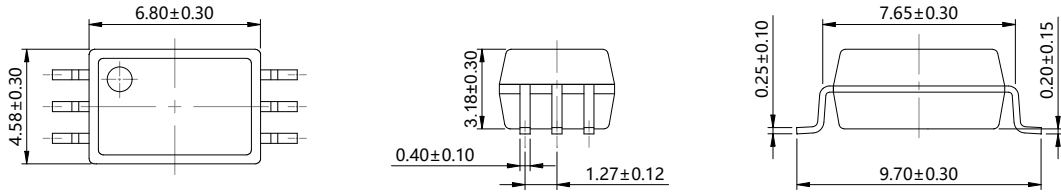

SOP6-W

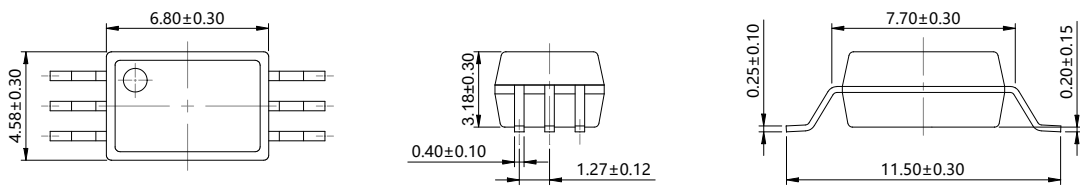

单位 Unit: mm

建议焊盘布局 Recommended Pad Layout

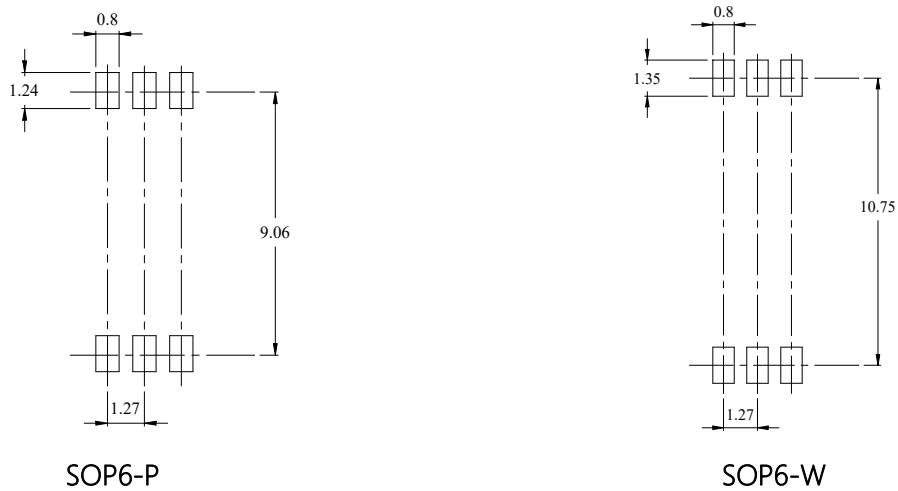

单位 Unit: mm

注：上图为产品正视图。

Note: The picture above is the front view of the product.

回流焊温度曲线图 Solder Reflow Profile

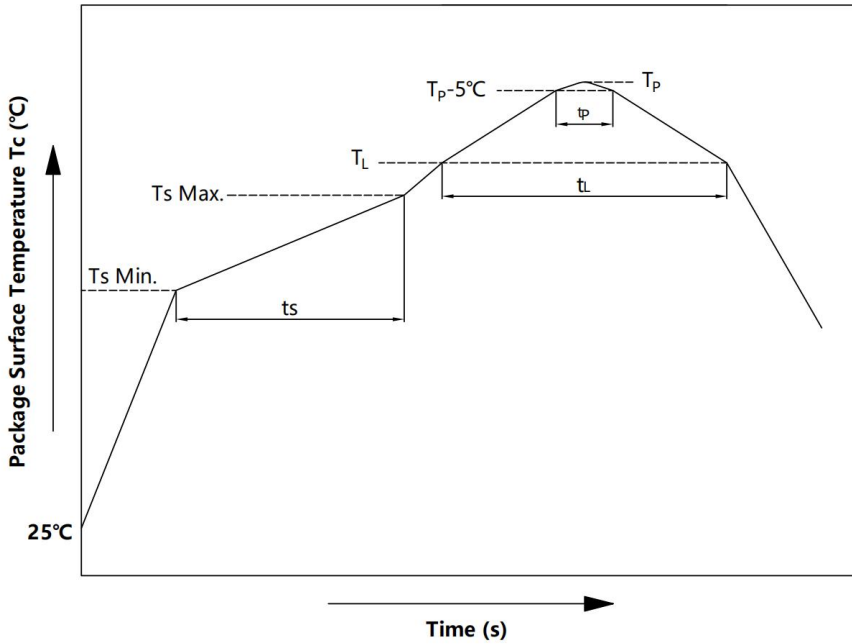

项目 Item	符号 Symbol	最小值 Min.	最大值 Max.	单位 Unit
预热温度 Preheat Temperature	T_s	150	200	$^\circ\text{C}$
预热时间 Preheat Time	t_s	60	120	s
升温速率 Ramp-Up Rate (T_L to T_P)	-	-	3	$^\circ\text{C}/\text{s}$
液相线温度 Liquidus Temperature	T_L	217		$^\circ\text{C}$
时间高于 T_L Time Above T_L	t_L	60	150	s
峰值温度 Peak Temperature	T_P	-	260	$^\circ\text{C}$
T_c 在 (T_P-5) 和 T_P 之间的时间 Time During Which T_c Is Between (T_P-5) and T_P	t_p	-	30	s
降温速率 Ramp-down Rate (T_P to T_L)	-	-	6	$^\circ\text{C}/\text{s}$

注 Note:

建议在所示的温度和时间条件下进行回流焊，最多不能超过三次；

Reflow soldering is recommended at the temperatures and times shown, no more than three times;

波峰焊温度曲线图 Wave Soldering Profile

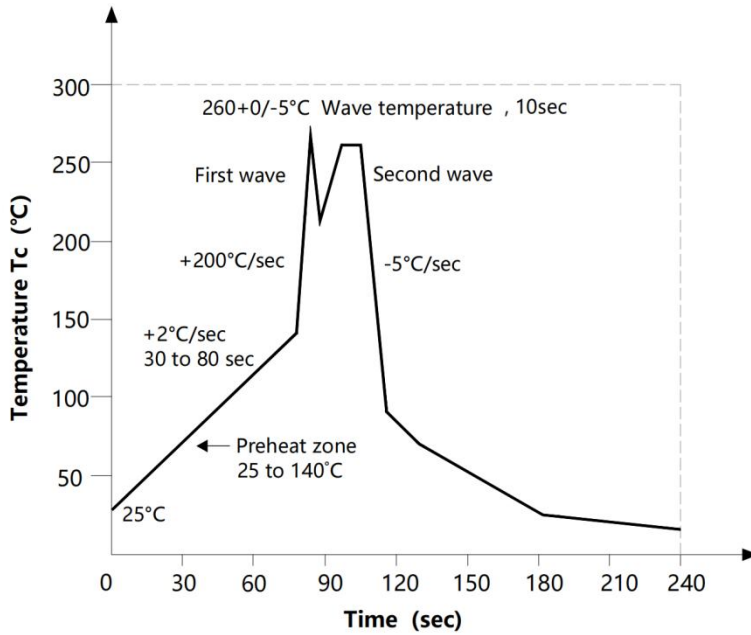

手工烙铁焊接 Soldering with hand soldering iron

- A. 手工烙铁焊仅用于产品返修或样品测试;
Hand soldering iron is only used for product rework or sample testing;
- B. 手工烙铁焊要求: 温度 $360^{\circ}\text{C} \pm 5^{\circ}\text{C}$, 时间 $\leq 3\text{s}$.
Hand soldering iron requirements: Temperature: $360^{\circ}\text{C} \pm 5^{\circ}\text{C}$, within 3s.

包装 Packing

■ 汇总表 Summary table

封装形式	包装方式	盘数量	盒数量	箱数量	静电袋规格	盒规格	箱(双瓦楞)规格	备注
SOP6	卷盘 (φ330mm 蓝盘)	1千只/盘	2 盘/盒	10 盒/箱	450*390*0.1mm	340*60*340mm	620*360*365mm	首尾端空至少 200mm
Package Type	Packing Form	Quantity per Reel	Quantity per Box	Quantity per Carton	Antistatic Bag Specification	Box Specification	Carton Specification	Note
SOP6	Reel(φ330mm Blue)	1k pcs/reel	2Reel/box	10box/ctn	450*390*0.1mm	340*60*340mm	620*360*365mm	Guard band 200mm min.

■ 编带包装 Tape & Reel

- 1) 每卷数量: 1000 只。
Qty/reel: 1000 pcs.
- 2) 每箱数量: 20000 只。
Qty/ctn: 20000 pcs.
- 3) 内包装: 每卷盘 1000 只。
Inner packing: 1000pcs/reel.
- 4) 示意图 Schematic:

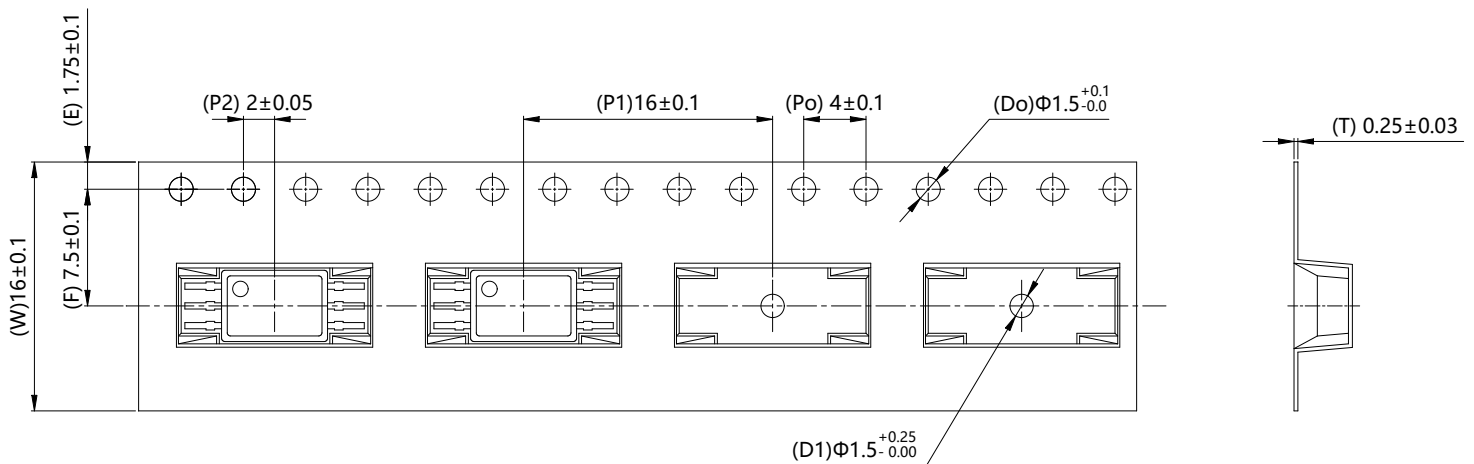

单位 Unit: mm

注意 Attention

- 群芯持续不断改进质量、可靠性、功能或设计，保留此文件更改的权利恕不另行通知。
QUNXIN continuously improve quality, reliability, function and design. We reserve the right to change this document without prior notice.
- 请遵守产品规格书使用，群芯不对使用时不符合产品规格书条件而导致的质量问题负责。
Please use in accordance with the product specification. QUNXIN is not responsible for the quality problems caused by non-compliance with the product specifications.
- 对于需要高可靠性或安全性的设备/装置需求，请联系我们的销售人员。
For equipment/devices requiring high reliability or safety, please contact our sales representatives.
- 当需要用于任何“特定”应用时，请咨询我们的销售人员。
When requiring a device for any “specific” application, please contact our sales in advice.
- 如对文件中表述的内容有疑问，欢迎联系我们。
If you have any questions about the contents of the document, please contact us.