



晶体管光耦

Photo Transistor

QX8801X

宁波群芯微电子股份有限公司

NINGBO QUNXIN MICROELECTRONICS CO., LTD.

中国 浙江省宁波杭州湾新区玉海东路 68 号

68 Yuhaidong Road, Hangzhou Bay New District, Ningbo, Zhejiang, China

概述 Description

QX8801X是一款由发光二极管和光电晶体管组成的光电耦合器。四引脚封装，六种形式（DIP、DIP-M、SMD、SOP、SSOP、LSOP）。

The QX8801X is a photoelectric coupler composed of light-emitting diode and phototransistor. It is packaged in a 4-pin package of six forms such as DIP、DIP-M、SMD、SOP、SSOP、LSOP.

特性 Features

- 电流转换比(CTR)范围: 80%~400% ($I_F=1\text{mA}$, $V_{CE}=5\text{V}$)
Current transfer ratio: 80%~400% ($I_F=1\text{mA}$, $V_{CE}=5\text{V}$)
- 输入-输出隔离电压 (SSOP4,SOP4:Viso=3750 Vrms;LSOP4,DIP4,DIP4-M,SMD4:Viso=5000Vrms)
High isolation voltage between input and output (SSOP4, SOP4: Viso=3750Vrms; LSOP4, DIP4, DIP4-M, SMD4: Viso=5000Vrms)
- 集电极-发射极击穿电压 $BV_{CEO} \geq 75\text{V}$
Collector - emitter breakdown voltage $BV_{CEO} \geq 75\text{V}$
- 工作温度: $-40^\circ\text{C} \sim +125^\circ\text{C}$
Operating Temperature: $-40^\circ\text{C} \sim +125^\circ\text{C}$
- 符合加强绝缘标准
Meet reinforced insulation standards
- 符合安规标准: UL 1577, VDE DIN EN60747-5-5 (VDE 0884-5) , CQC11-471543-2022
Meet safety standard approval: UL 1577, VDE DIN EN60747-5-5 (VDE 0884-5) , CQC11-471543-2022
- AEC-Q101 合格 (For SSOP4)
AEC-Q101 qualified (For SSOP4)

应用 Applications

- DC-DC 转换器
DC-DC converter
- 通讯设备
Communications equipment
- 可编程控制器
Programmable controller
- 信号传输
Signal transmission

封装和原理图 Package and Schematic Diagram

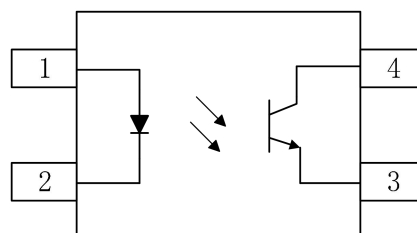
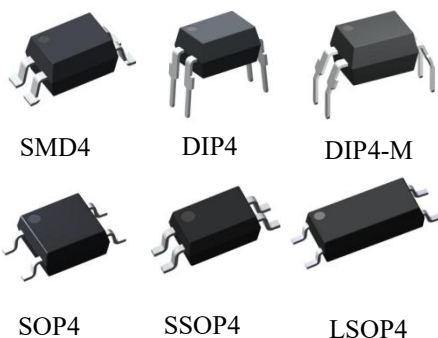

Pin Configuration

1. Anode
2. Cathode
3. Emitter
4. Collector

产品型号命名规则 Order Code

QX 8801 X - UN Y - W (V) (ZZ)

① ② ③ ④ ⑤ ⑥ ⑦ ⑧

- ① 公司代码 Company Code (QX: 群芯 Qunxin)
- ② 产品系列 Product Series (8801: 8801)
- ③ CTR 档位 Classification A、B、C 或无 (代码 Code: A、B、C or None)
- ④ 框架类型 Lead Frame (Cu: 铜框架 Copper)
- ⑤ 树脂类型 Epoxy Type (H: 无卤 Halogen-free)
- ⑥ 封装形式 Package (D:DIP4、M:DIP4-M、R:SMD4、T:SOP4、S:SSOP4、L:LSOP4)
- ⑦ 器件工作温度范围 Device Operating Temperature Range (特殊范围需填或者空白 Special Range need to be filled in or left blank)
- ⑧ 内部补充代码 Internal Supplementary Code (数字或者空白 Number or None)

印字信息 Marking Information



LSOP4 SSOP4



SOP4



DIP4 SMD4 DIP4-M

- 印字中“G”为群芯品牌 LOGO
“G”denotes LOGO
- 印字中的“X”代表产品分档: A、B、C 或无
“X”denotes the classification: A、B、C or None
- 印字中“Y”代表年份; A(2018),B(2019),C(2020).....
“Y”denotes YEAR: A(2018), B(2019), C(2020).....
- 印字中“WW”代表周号
“WW”denotes Week's number
- 印字中“N”代表星期几
“N”denotes day of the week
- 印字中的“H”代表无卤
“H”denotes Halogen-free

绝缘和安规信息 Insulation and Safety related specifications

项目 Item	符号 Symbol	封装 SOP-4, SSOP-4	封装 DIP4, DIP4-M SMD-4	封装 LSOP-4	单位 Unit	备注 Remark
爬电距离 Creepage Distance	L	> 5.0	> 7.0	> 8.0	mm	从输入端到输出端，沿本体最短距离路径 Measured from input terminals to output terminals, shortest distance path along body
电气间隙 Clearance Distance	L	> 5.0	> 7.0	> 8.0	mm	从输入端到输出端，通过空气的最短距离 Measured from input terminals to output terminals, shortest distance through air
绝缘距离 Insulation Thickness	DTI	> 0.4	> 0.4	> 0.4	mm	发射器和探测器之间的绝缘厚度 Insulation thickness between emitter and detector
峰值隔离电压 Peak Isolation Voltage	V_{IORM}	600	1500	1500	V_{peak}	DIN/EN/IEC EN60747-5-5
瞬态隔离电压 Transient isolation voltage	V_{IOTM}	5000	7000	7000	V_{peak}	DIN/EN/IEC EN60747-5-5
隔离电压 Isolation Voltage	V_{iso}	> 3750	> 5000	> 5000	V_{rms}	For 1 min

极限参数 Absolute Maximum Ratings ($T_a=25^{\circ}C$)

参数 Parameter		符号 Symbol	额定值 Rating		单位 Unit	
发射端 Input	正向电流 Forward Current	I_F	20		mA	
	反向电压 Reverse Voltage	V_R	6		V	
	功耗 Power Dissipation	P_D	DIP4	70		mW
			DIP4-M	70		
			SMD4	70		
			SOP4	70		
LSOP4			70			
SSOP4	40					
接收端 output	集电极功耗 Collector Power Dissipation	P_C	150		mW	
	集电极电流 Collector Current	I_C	50		mA	

参数 Parameter		符号 Symbol	额定值 Rating		单位 Unit
	集电极-发射极电压 Collector-Emitter Voltage	V_{CEO}	75		V
	发射极-集电极电压 Emitter-Collector Voltage	V_{ECO}	7		V
总功耗 Total Power Dissipation		P_{tot}	150		mW
隔离电压 Isolation Voltage		V _{iso}	DIP4	5000	V _{rms}
			DIP4-M	5000	
			SMD4	5000	
			LSOP4	5000	
			SOP4	3750	
			SSOP4	3750	
工作温度 Operating Temperature		T_{opr}	-40~+125		°C
存储温度 Storage Temperature		T_{stg}	-40~+150		°C
焊接温度 Soldering Temperature		T_{sol}	260		°C

产品特性参数 Electro-optical Characteristics (Ta=25°C)

参数 Parameter		符号 Symbol	条件 Condition	最小 Min.	典型 Typ.	最大 Max.	单位 Unit	
发射端 Input	正向电压 Forward Voltage	V_F	$I_F=1mA$	1.0	1.35	1.8	V	
	反向电流 Reverse Current	I_R	$V_R=6V$	-	-	10	μA	
	输入电容 Terminal Capacitance	C_t	$V=0, f=1KHz$	-	30	-	pF	
接收端 Output	集电极暗电流 Collector Dark Current	I_{CEO}	$V_{CE}=75V$	-	-	100	nA	
	集电极-发射极击穿电压 Collector-Emitter Breakdown Voltage	BV_{CEO}	$I_C=0.5mA, I_F=0mA$	75	130	-	V	
	发射极-集电极击穿电压 Emitter-Collector Breakdown Voltage	BV_{ECO}	$I_E=0.1mA, I_F=0$	7	12	-	V	
传输特性 Transfer Characteristics	电流传输比 Current Transfer Ratio	CTR^*	$I_F=1mA, V_{CE}=5V$	80	-	400	%	
	电流传输比 (饱和) Saturation Current Transfer Ratio	$CTR_{CE(sat)}$	$I_F=1mA, V_{CE}=0.4V$	65	-	380	%	
	集电极-发射极饱和压降 Collector-Emitter Saturation Voltage	$V_{CE(sat)}$	A 档	$I_F=1.0mA, I_C=0.3mA$	-	0.17	0.4	V
				$I_F=1.6mA, I_C=0.4mA$		0.16	0.4	
				$I_F=3.0mA, I_C=0.6mA$		0.15	0.4	
			B 档	$I_F=1.0mA, I_C=0.45mA$		0.17	0.4	
				$I_F=1.6mA, I_C=0.6mA$		0.16	0.4	
				$I_F=3.0mA, I_C=1mA$		0.16	0.4	
			C 档	$I_F=1.0mA, I_C=0.75mA$		0.18	0.4	
				$I_F=1.6mA, I_C=1mA$		0.17	0.4	
$I_F=3.0mA, I_C=1.6mA$				0.17		0.4		
隔离电阻 Isolation Resistance	R_{ISO}	DC500V, 40~60%R.H.	1×10^{12}	-	-	Ω		
隔离电容 Isolation Capacitance	C_{ISO}	$V=0, f=1MHz$	-	0.3	0.5	pF		
上升时间 Rise Time	T_r	$I_F=1.6mA$ $V_{CC}=5V$ $R_L=0.75k\Omega$	-	5	-	μs		
下降时间 Fall Time	T_f		-	5.5	-	μs		
开启时间 Turn-on time	T_{ON}		1	6	20	μs		
关断时间 Turn-off time	T_{OFF}		1	6	20	μs		

注*: 电流传输比= $I_C/I_F \times 100\%$ 。

Note*: $CTR=I_C/I_F \times 100\%$ 。

电流传输比分档表 CTR Classification Table ($I_F=1\text{mA}$, $V_{CE}=5\text{V}$)

代码 Code	最小值 Min.	最大值 Max.
A	80	160
B	130	260
C	200	400
N	200	260
None	80	400

典型光电特性曲线 Typical Electro-Optical Characteristics Curves

Fig.1 Relative Current Transfer Ratio vs. Forward Current

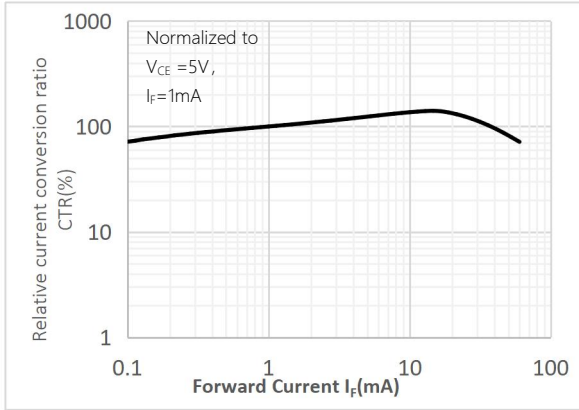

Fig.2 Forward Current vs. Forward Voltage

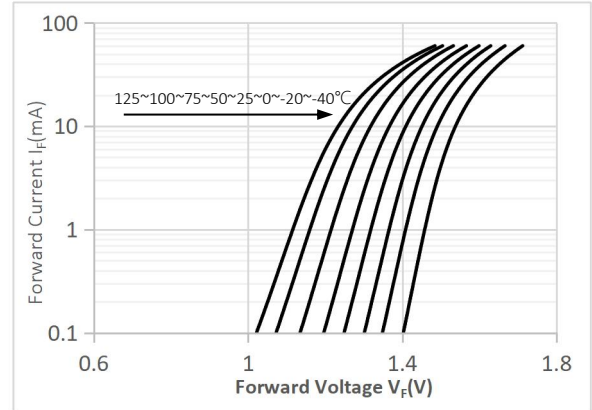

Fig.3 Collector Current vs. Collector-emitter Voltage

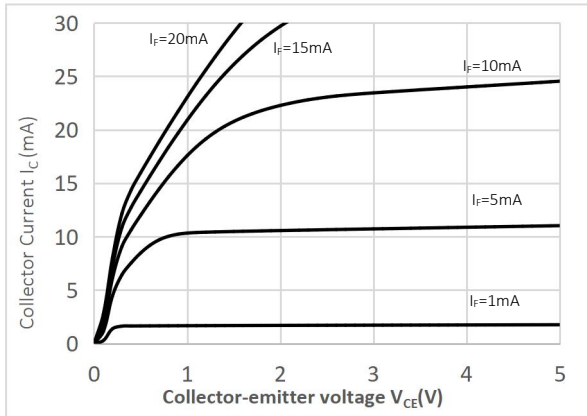

Fig.4 Collector Current vs Forward Current

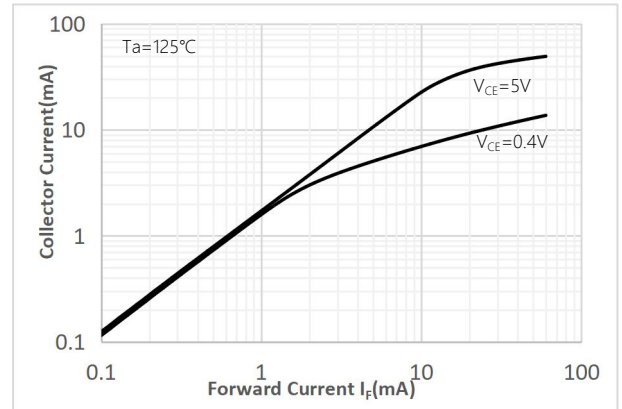

Fig.5 Relative Current Transfer Ratio vs. Ambient Temperature

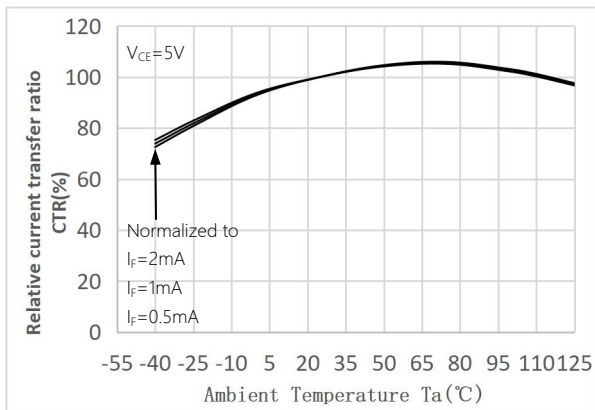

Fig.6 Relative Current Transfer Ratio vs. Ambient Temperature

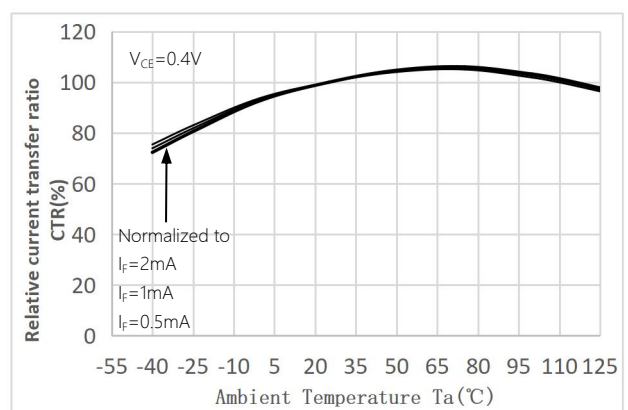

Fig.7 Collector Current vs Ambient Temperature

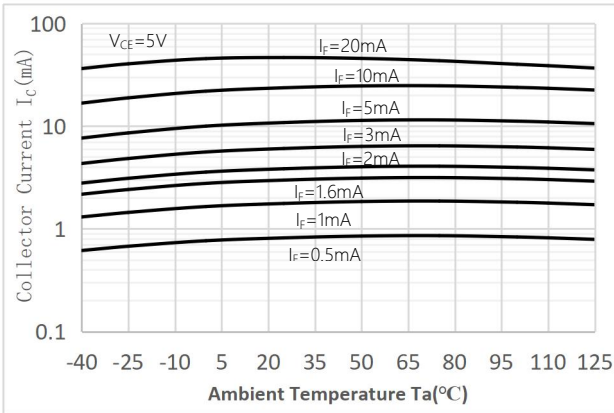

Fig.9 Collector-emitter Saturation Voltage vs. Ambient Temperature

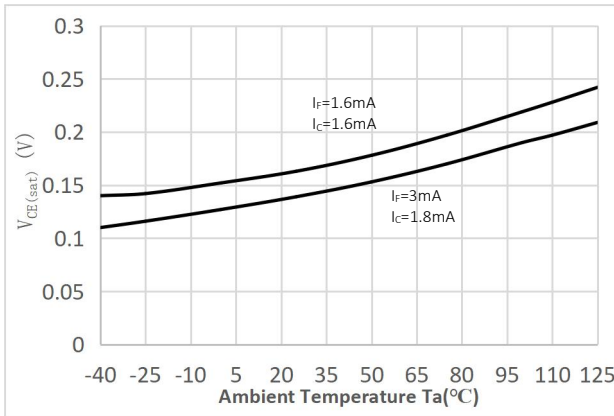

Fig.11 Switching Time Test Circuit & Wave forms

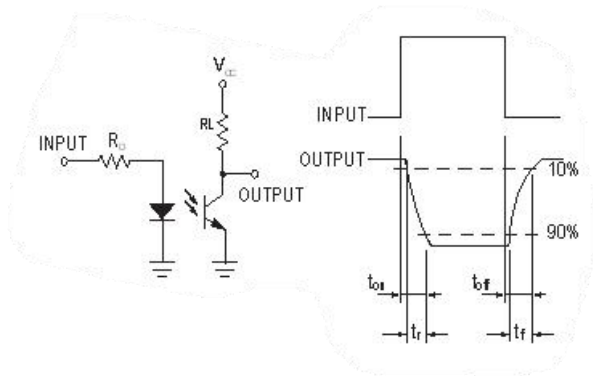

Fig.8 Collector Dark Current vs Ambient Temperature

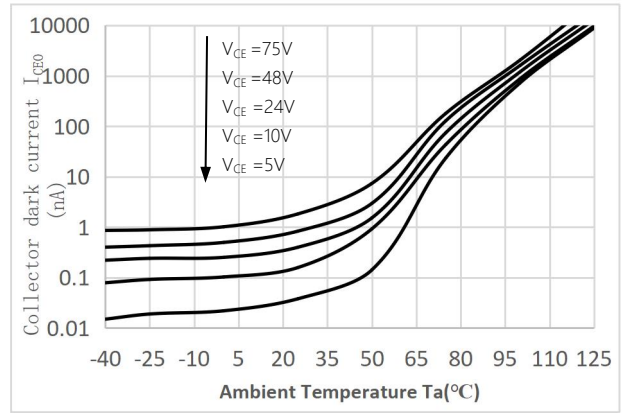
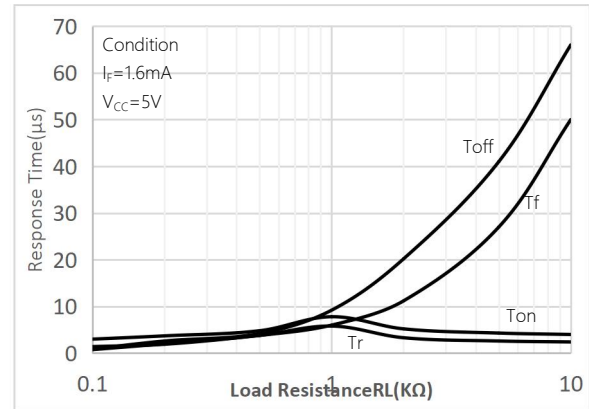
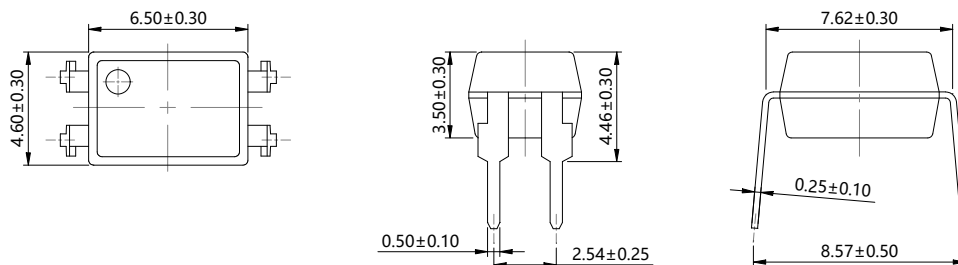

Fig.10 Response Time vs. Load Resistance



外形尺寸 Outline Dimensions

DIP4



DIP4-M

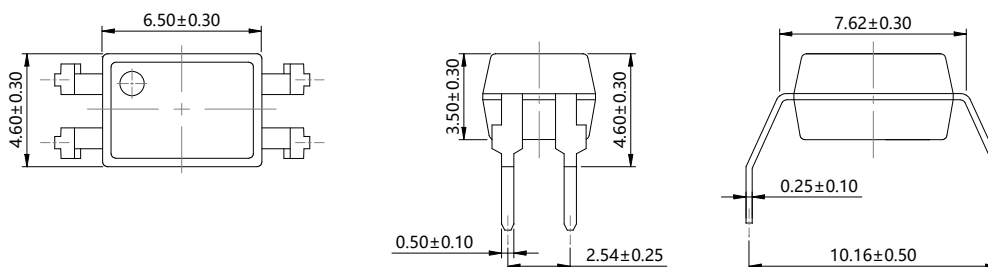

SMD4

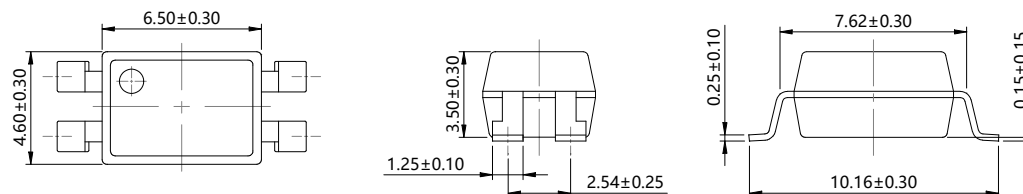

SOP4

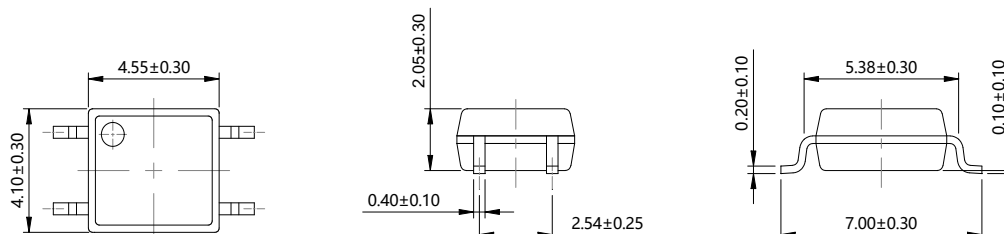

SSOP4

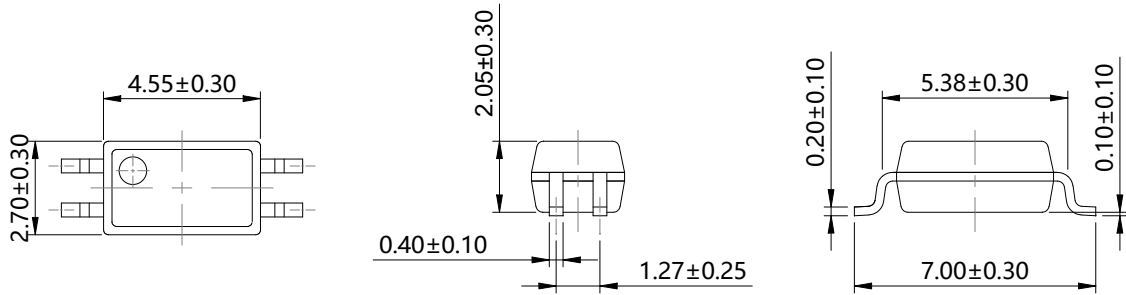

LSOP4

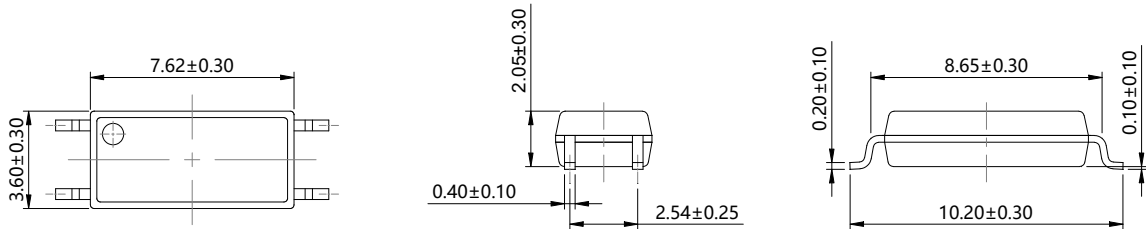

单位 Unit: mm

建议焊盘布局 Recommended Pad Layout

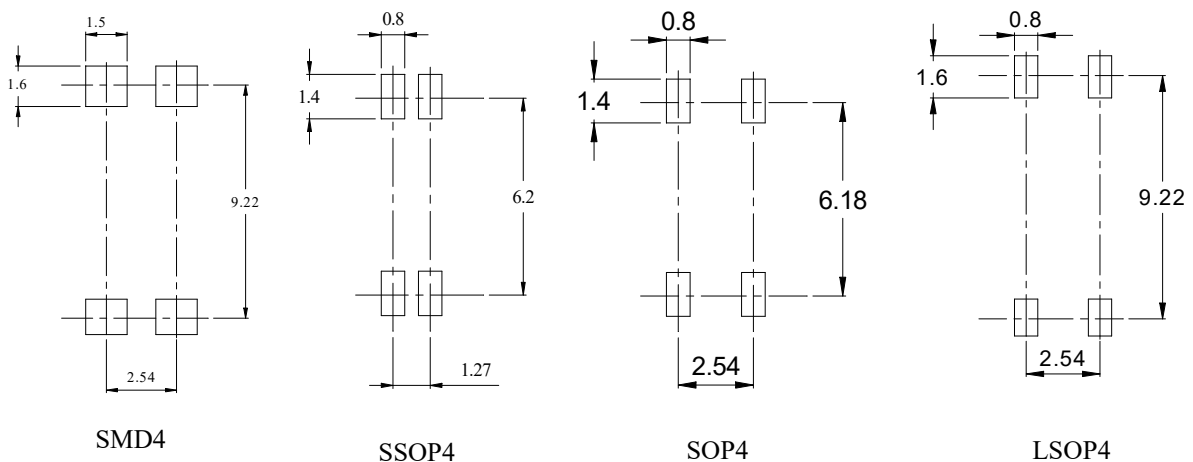

单位 Unit: mm

注：上图为产品正视图。

Note: The picture above is the front view of the product.

回流焊温度曲线图 Solder Reflow Profile

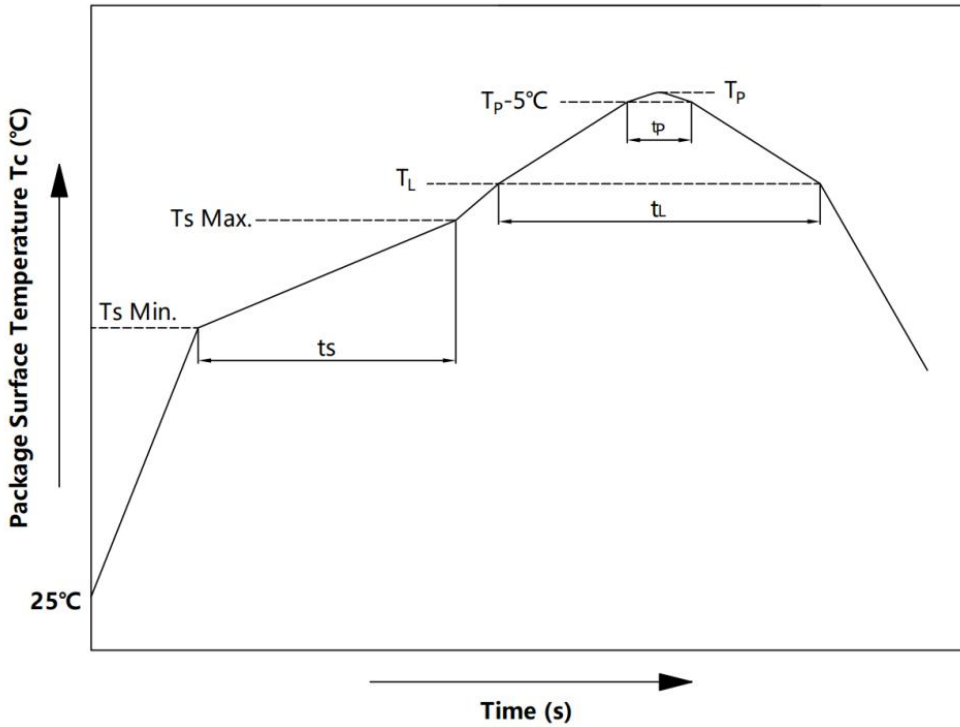

项目 Item	符号 Symbol	最小值 Min.	最大值 Max.	单位 Unit
预热温度 Preheat Temperature	T_s	150	200	°C
预热时间 Preheat Time	t_s	60	120	s
升温速率 Ramp-Up Rate (T_L to T_p)	-	-	3	°C/s
液相线温度 Liquidus Temperature	T_L	217		°C
时间高于 T_L Time Above T_L	t_L	60	150	s
峰值温度 Peak Temperature	T_p	-	260	°C
T_c 在 (T_p-5) 和 T_p 之间的时间 Time During Which T_c Is Between (T_p-5) and T_p	t_p	-	30	s
降温速率 Ramp-down Rate (T_p to T_L)	-	-	6	°C/s

注 Note:

建议在所示的温度和时间条件下进行回流焊，最多不能超过三次；

Reflow soldering is recommended at the temperatures and times shown, no more than three times;

波峰焊温度曲线图 Wave Soldering Profile

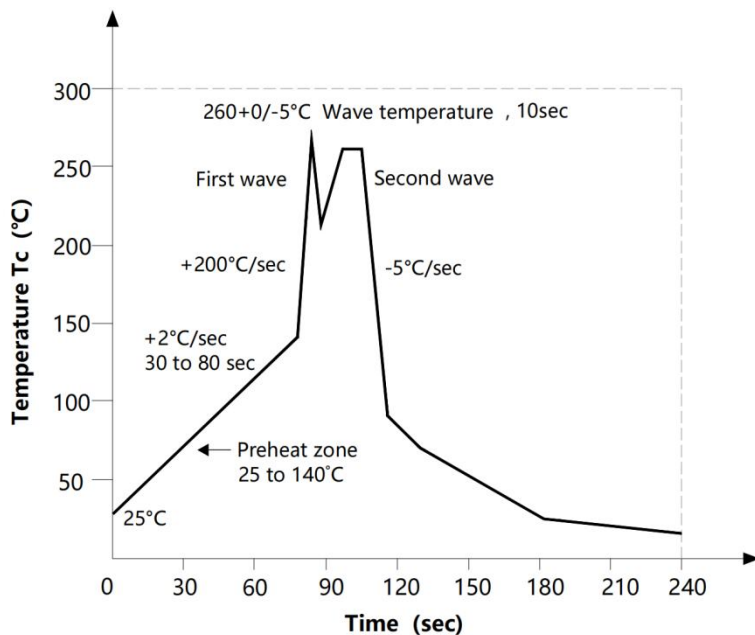

手工烙铁焊接 Soldering with hand soldering iron

A. 手工烙铁焊仅用于产品返修或样品测试;

Hand soldering iron is only used for product rework or sample testing;

B. 手工烙铁焊要求：温度 $360^{\circ}\text{C} \pm 5^{\circ}\text{C}$ ，时间 $\leq 3\text{s}$ 。

Hand soldering iron requirements: Temperature: $360^{\circ}\text{C} \pm 5^{\circ}\text{C}$, within 3s.

包装 Packing

■ 汇总表 Summary table

封装形式	包装方式	盘数量	盒数量	箱数量	静电袋规格	盒规格	箱(双瓦楞)规格	备注
DIP4	管装 (500*13*11mm)	100 只/管	50 管/盒	10 盒/箱	不适用	525*128*56mm	535*285*30mm	每管使用蓝白胶塞, 方向须一致
DIP4-M	管装 (500*13*11mm)	100 只/管	45 管/盒	10 盒/箱	不适用	525*136*58mm	535*295*310mm	每管使用蓝白胶塞, 方向须一致
SMD4	卷盘 (φ330mm 蓝盘)	2000 只/盘	2 盘/盒	10 盒/箱	450*390*0.1m m	340*60*340mm	620*360*365mm	首端各空 50 个空格, 末端空 100
SOP4	卷盘 (φ330mm 蓝盘)	3000 只/盘	2 盘/盒	10 盒/箱	450*390*0.1m m	340*60*340mm	380*360*365mm	首端各空 50 个空格, 末端空 100
SSOP4	卷盘 (φ330mm 蓝盘)	3000 只/盘	2 盘/盒	10 盒/箱	450*390*0.1m m	340*60*340mm	380*360*365mm	首端各空 50 个空格, 末端空 100
LSOP4	卷盘 (φ330mm 蓝盘)	3000 只/盘	2 盘/盒	10 盒/箱	450*390*0.1m m	340*60*340mm	380*360*365mm	首端各空 50 个空格, 末端空 100
Package Type	Packing Form	Quantity per Reel	Quantity per Box	Quantity per Carton	Antistatic Bag Specification	Box Specification	Carton Specification	Note
DIP4	Tube (500*12*11mm)	100 pcs /tube	50 tubes/box	10 boxes/ctn	NA	525*128*56mm	535*285*30mm	Use blue and white rubber plugs for each tube in the same direction
DIP4-M	Tube (500*13*11mm)	100 pcs /tube	45 tubes/box	10 boxes/ctn	NA	525*136*58mm	535*295*310mm	Use blue and white rubber plugs for each tube in the same direction
SMD4	Reel (φ330mm Blue)	3000 pcs/reel	2 reels /box	10 boxes /ctn	450*390*0.1m m	340*60*340mm	620*360*365mm	Leave 50 Spaces at the beginning and 100 Spaces at the end
SOP4	Reel (φ330mm Blue)	3000 pcs/reel	2 reels /box	10 boxes /ctn	450*390*0.1m m	340*60*340mm	380*360*365mm	Leave 50 Spaces at the beginning and 100 Spaces at the end
SSOP4	Reel (φ330mm Blue)	3000 pcs/reel	2 reels /box	10 boxes /ctn	450*390*0.1m m	340*60*340mm	380*360*365mm	Leave 50 Spaces at the beginning and 100 Spaces at the end
LSOP4	Reel (φ330mm Blue)	3000 pcs/reel	2 reels /box	10 boxes /ctn	450*390*0.1m m	340*60*340mm	380*360*365mm	Leave 50 Spaces at the beginning and 100 Spaces at the end

■ DIP-4, DIP4-M 条管包装 Tape & Tube

- 1) 每管数量: 100 只。
Qty/Tube: 100 pcs.
- 2) 每箱数量 DIP4/DIP4-M: 50000/45000 只。
Qty/ctn DIP4/DIP4-M: 50000/45000 pcs.
- 3) 内包装 DIP4/DIP4-M: 每盒 50/45 管。
Inner packing DIP4/DIP4-M: 50/45 Tube/box.
- 4) 示意图 Schematic:

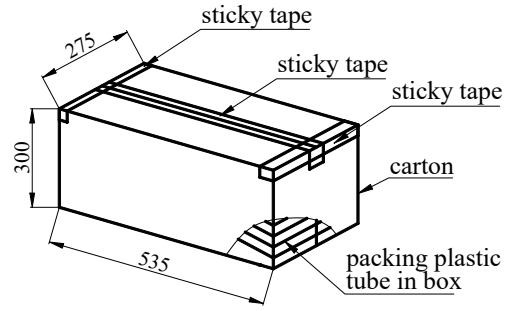

■ SMD4 编带包装 Tape & Reel

- 4) 每卷数量: 2000 只。
Qty/reel: 2000 pcs.
- 5) 每箱数量: 40000 只。
Qty/ctn: 40000 pcs.
- 6) 内包装: 每盒 2 盘。
Inner packing: 2 reels/box.
- 7) 示意图 Schematic: (单位 Unit: mm)

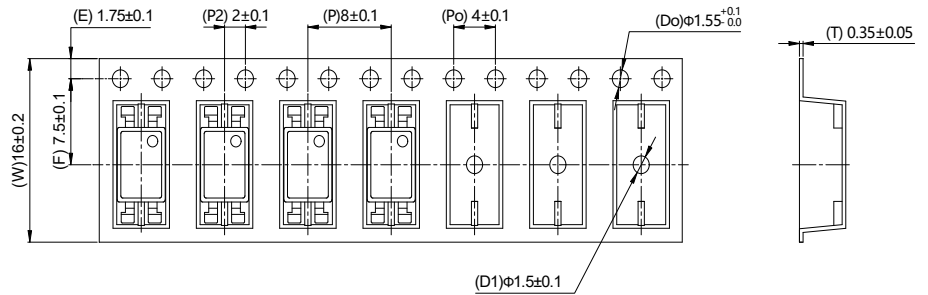

■ SOP4 编带包装 Tape & Reel

- 1) 每卷数量: 3000 只。
Qty/reel: 3000 pcs.
- 2) 每箱数量: 60000 只。
Qty/ctn: 60000 pcs.
- 3) 内包装: 每盒 2 盘。
Inner packing: 2 reels/box.
- 4) 示意图 Schematic: (单位 Unit: mm)

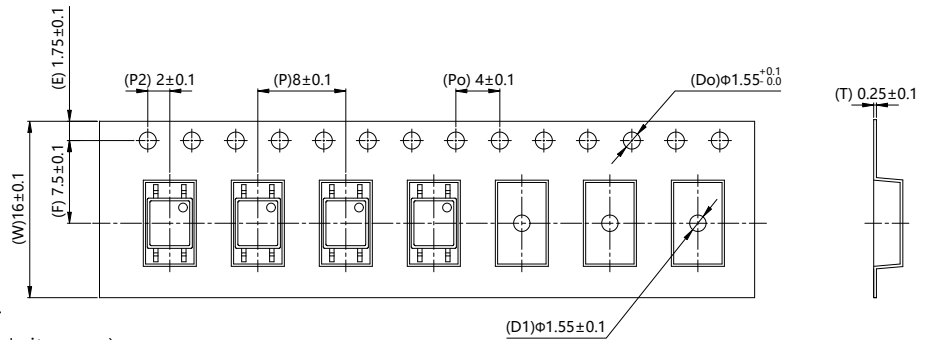

■ LSOP4 编带包装 Tape & Reel

- 8) 每卷数量: 3000 只。
Qty/reel: 3000 pcs.
- 9) 每箱数量: 60000 只。
Qty/ctn: 60000 pcs.
- 10) 内包装: 每盒 2 盘。
Inner packing: 2 reels/box.
- 11) 示意图 Schematic: (单位 Unit: mm)

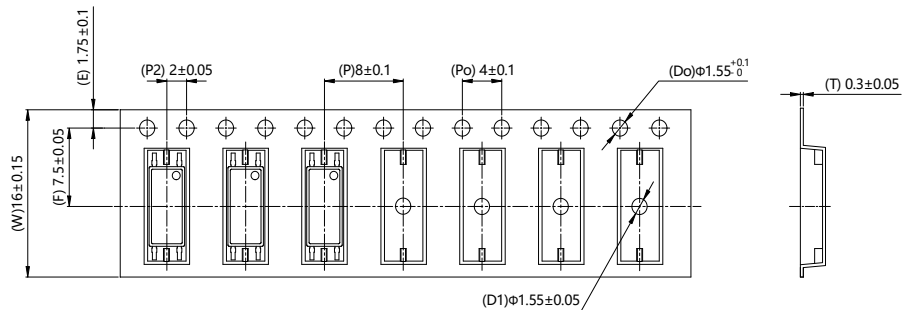

■ SSOP4 编带包装 Tape & Reel

- 12) 每卷数量: 3000 只。
Qty/reel: 3000 pcs.
- 13) 每箱数量: 60000 只。
Qty/ctn: 60000 pcs.
- 14) 内包装: 每盒 2 盘。
Inner packing: 2 reels/box.
- 15) 示意图 Schematic: (单位 Unit: mm)

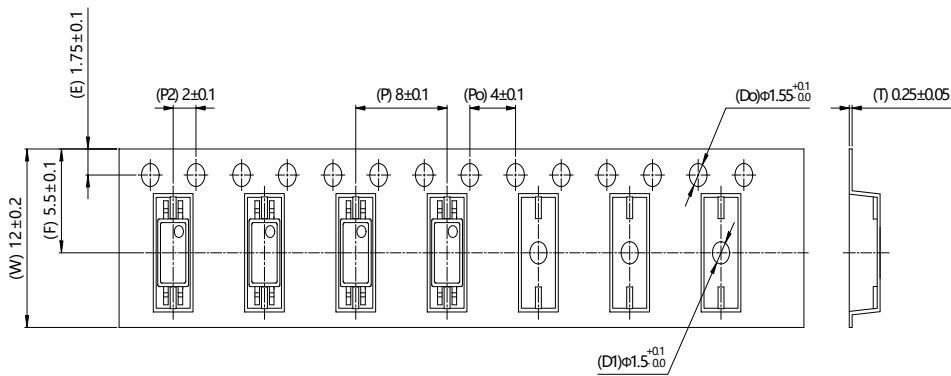

注意 Attention

- 群芯持续不断改进质量、可靠性、功能或设计，保留此文件更改的权利恕不另行通知。
QUNXIN continuously improve quality, reliability, function and design. We reserve the right to change this document without prior notice.
- 请遵守产品规格书使用，群芯不对使用时不符合产品规格书条件而导致的质量问题负责。
Please use in accordance with the product specification. QUNXIN is not responsible for the quality problems caused by non-compliance with the product specifications.
- 对于需要高可靠性或安全性的设备/装置需求，请联系我们的销售人员。
For equipment/devices requiring high reliability or safety, please contact our sales representatives.
- 当需要用于任何“特定”应用时，请咨询我们的销售人员。
When requiring a device for any “specific” application, please contact our sales in advice.
- 如对文件中表述的内容有疑问，欢迎联系我们。
If you have any questions about the contents of the document, please contact us.